

## Anaesthesia Instruments

Laryngoscopes  
Laryngoskope

Laryngoscopes  
Laringoscopios

### MACOMTOSH FIBER OPTIC



09-1659-29

#### ADVANTAGES

Fiber optic blades with German Bulb  
Fiber optic illumination  
assembly is detachable  
and is easy to clean.  
Maintain and re-polished.  
Thousands of fiber strings  
are firmly secured in stainless steel  
pipe cover which saves  
from damage or breakage.



Fig.4



Fig.3



Fig.2



Fig.1

### MILLER FIBER OPTIC



09-1660-30



Fig.4



Fig.3



Fig.2



Fig.1

# Anaesthesia Instruments

Laryngoscopes  
Laryngoskope

Laryngoscopes  
Laringoscopios

**WITTEX**  
International

10

## MILLER CONVENTIONAL



09-1661-01



Fig.4



Fig.3



Fig.2



Fig.1

### ADVANTAGES

**Handles**  
Brass  
Universal Fitting with  
Non Magnetic pin

**Blades**  
Stainless Steel  
Non Magnetic  
with german bulb

## MACINTOSH CONVENTIONAL



09-1662-02



Fig.4



Fig.3



Fig.2



Fig.1

## Anaesthesia Instruments

Laryngoscopes  
Laryngoskope

Laryngoscopes  
Laringoscopios

### DIAGNOSTIC ENT SET



09-1663-33

### OTOSCOPE SET WITH CASE



09-1664-34

# Anaesthesia Instruments

Laryngoscopes  
Laryngoskope

Laryngoscopes  
Laringoscopios

## Laryngoscope Set, Handle & Blades



10-1665-00



Miller Baby  
10-1666-00



10-1667-00  
Magil Set of 4 Blade  
Size : 1,2,3,4 1Medium Hadle  
1 Small & 1Large spare Lamp packed in  
Strong Plastic Casing with Foam Inserting

## FIBEROPTIC HANDLES



Fig.1



Fig. 2



Fig. 3



Fig. 4

10-1668-00

### ADVANTAGES

Choice of Xenon & Halogen lamps available.  
All types of standard lamp threads available.  
Easy to replace lamp  
Handles fitting is compatible

### ADVANTAGES

High quality long life handles  
Handles fitting is compatible

## CONVENTIONAL HANDLES



Fig.1



Fig. 2



Fig. 3



Fig. 4

10-1668-39

**TONGUE DEPRESSOR**



10-1668-A

**PEN TORCH**



10-1668-B

**MINI OTOSCOPE FIBER OPTICS**



10-1668-C



10-1668-D



10-1668-E

Available in colour



10-1668-F

10-1668-G

10-1668-H

# Anaesthesia Instruments

Otosopes  
Otoskope

Otosopes  
Otoskopios

 **WITTEX**  
International

10

## METAL BODY OTOSCOPIES



10-1668-J

10-1668-K

## OPHTHALMOSCOPIES



10-1668-M

10-1668-N



10-1668-L

# Anaesthesia Instruments

Suction Tubes  
Saugrohre

Tubes d'aspiration  
tubos de succión



Ømm	Fergusson Charr./Fr.
2	6 10-1669-06
2 1/3	7 10-1669-07
2 2/3	8 10-1669-08
3	9 10-1669-09
3 1/3	10 10-1669-10
4	11 10-1669-12
4 3/4	12 10-1669-14

17cm/6 3/4"



Ømm	Frazier Charr./Fr.
2	6 10-1670-06
2 1/3	7 10-1670-07
2 2/3	8 10-1670-08
3	9 10-1670-09
3 1/3	10 10-1670-10
4	12 10-1670-12
4 3/4	14 10-1670-14
5 1/4	16 10-1670-16

17cm/6 3/4"

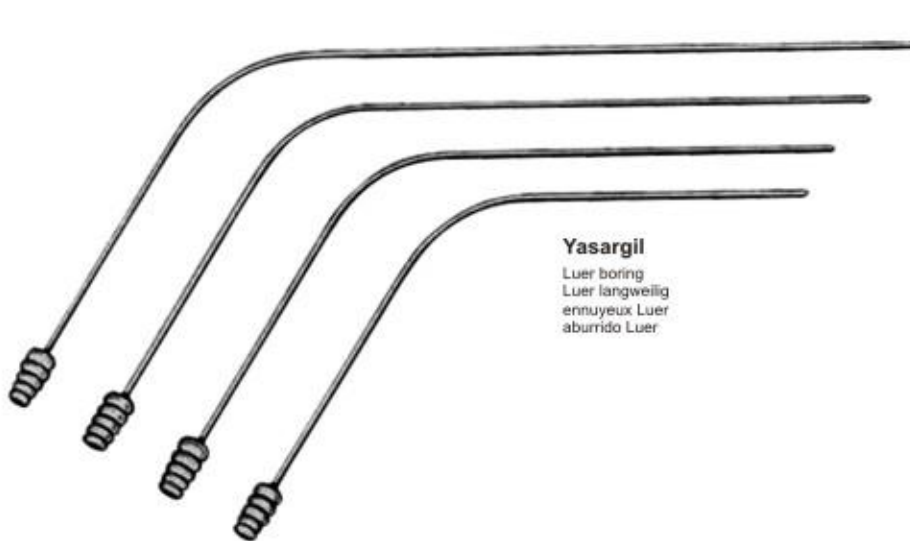

**Yasargil**  
Luer boring  
Luer langweilig  
ennuyeux Luer  
aburrido Luer

usable length cm	Ømm diam
13	1.5 10-1671-13
15	1.5 10-1671-15
18	1.5 10-1671-18
22	1.5 10-1671-22
13	2.0 10-1672-13
15	2.0 10-1672-15
18	2.0 10-1672-18
22	2.0 10-1672-22
13	2.5 10-1673-13
15	2.5 10-1673-15
18	2.5 10-1673-18
22	2.5 10-1673-22
13	3.5 10-1674-13
15	3.5 10-1674-15
18	3.5 10-1674-18
22	3.5 10-1674-22
18	4.5 10-1674-18

Ømm	
1.7	10-1675-17
2.5	10-1676-25
3.5	10-1677-35

malleable  
formbar  
malleable  
maleable

**Yasargil**

# Anaesthesia Instruments

Suction Tubes  
Saugrohre

Tubes d'aspiration  
tubos de succión

**WITTEX**  
International

10



2.0 mm  
3.0 mm  
4.0 mm  
5.0 mm

malleable, black  
Temperguss, schwarz  
malléable, noire  
maleable, negro

∅	
2 mm	10-1678-02
3 mm	10-1678-03
4 mm	10-1678-04
5 mm	10-1678-05
	19.5cm/7"

Brain Suction Tubes  
Gehirn Saugschläuche  
Tubes d'aspiration du cerveau  
Los tubos de succión del cerebro



∅	<b>Plester</b>
1.5 mm	10-1680-15
2.0 mm	10-1680-20
2.5 mm	10-1680-25
3.0 mm	10-1680-30
	19.5cm/7 3/4"



**Adson**  
∅4 mm

**Adson**  
10-1679-50  
21 cm/8 1/4"



∅	<b>Frazier</b>
2.0 mm	10-1681-20
2.5 mm	10-1681-25
3.0 mm	10-1681-30
	13cm/5"



## Anaesthesia Instruments

Suction Tubes  
Saugrohre

Tubes d'aspiration  
tubos de succión

Ø 8 mm



**Poole**  
10-1682-59  
22cm/8¾"

Ø 10 mm



**Poole**  
10-1683-60  
22cm/8¾"

Ø 6 mm



**Baby-Poole**  
10-1684-61  
20cm/8"

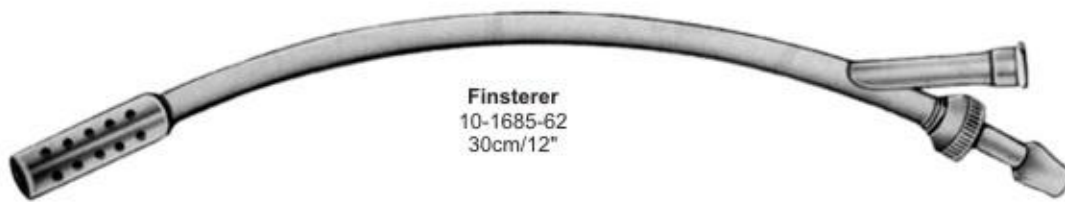

**Finsterer**  
10-1685-62  
30cm/12"

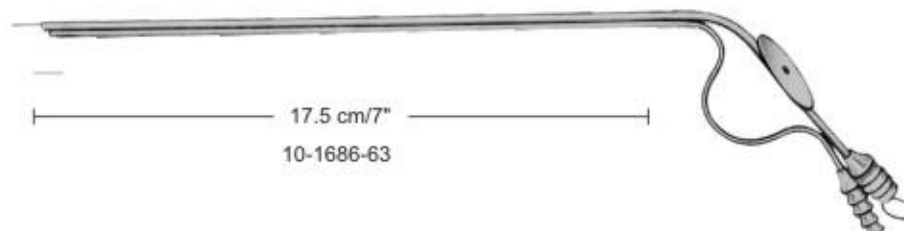

17.5 cm/7"  
10-1686-63

# Anaesthesia Instruments

Suction Tubes  
Saugrohre

Tubes d'aspiration  
tubos de succión

**WITTEX**  
International

10



Fig. 3  
10-1687-03



Fig. 2  
10-1687-02



Fig. 1  
10-1687-01



Fig. 0  
10-1687-00



Yankauer  
10-1688-53



with stopcock  
mit Hahn  
avec robinet d'arrêt  
con llave de paso

Yankauer  
10-1689-54  
27cm/10½"

Yankauer  
10-1690-55  
27cm/1ft "



Andrew-Pynchon  
10-1691-56  
23 cm/9"



Nuboer  
10-1692-57  
21cm/8¼"



Nuboer  
10-1693-58  
21cm/8¼"

## Anaesthesia Instruments

Suction Tubes  
Saugrohre

Tubes d'aspiration  
tubos de succión

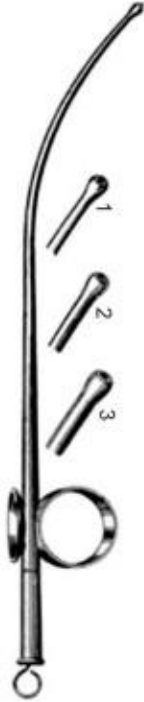

**Magill**

10-1694-01=20cm/8"  
10-1694-02=20cm/8"  
10-1694-03=20cm/8"

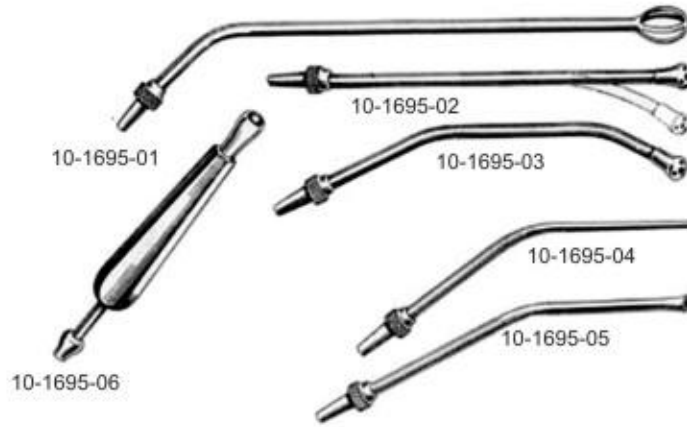

**Yankauer universal**  
Complete Set  
10-1695-65



**Yankauer**  
10-1696-34  
34.5cm/13 1/4"



**Simpson-Smith**  
10-1697-67



**Millin**  
10-1698-30  
30cm/12"

# Anaesthesia Instruments

Nasal and Ear Cannulas  
Nasen-und Ohr-Kanülen

Nasen-und Ohr-Kanülen...  
Cánulas nasales y del oído



**Magill**

10-1699-69  
25cm/10"

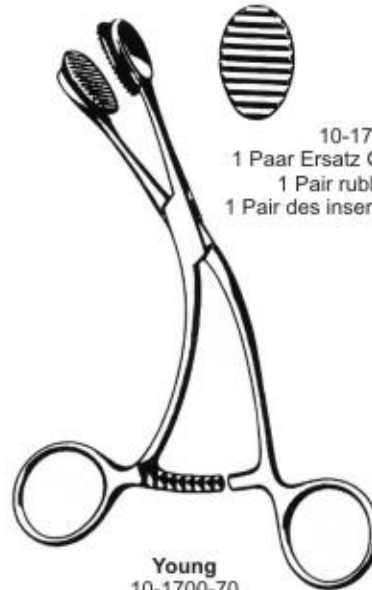

**Young**  
10-1700-70  
17cm/6 3/4"

10-1700-70  
1 Paar Ersatz Gummieinsätze  
1 Pair rubber inserts  
1 Pair des inserts en caoutchouc



**Collin**  
10-1701-16 16cm/6 1/2"  
10-1701-17 17cm/6 3/4"  
10-1701-19 19cm/7 1/2"



**Bosworth**  
10-1702-72

**Tobold**  
10-1702-14  
14.5cm/5 1/2"



**Sternberg**  
10-1703-12 12cm/6 3/4"  
10-1703-14 14cm/5 1/2"  
10-1703-16 16cm/6 1/4"



**Connel**  
09-1704-01 Child  
09-1704-02 Adult

## Anaesthesia Instruments

Cheek Retractors - Tongue depressors-Catheter forceps  
Wangenhalter - Zungenspatel-Katheter Zange

Écarteurs - Langue abaisse-cathéter forceps  
Los retractores mejilla - Lengua depresores-catéter fórceps

10

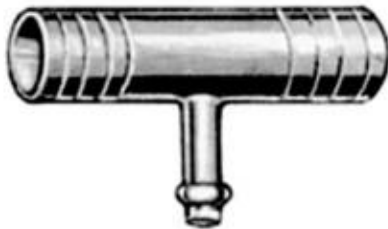

**Ayre**

10-1705-01	Small	Small	Medium	Large
10-1704-02	Medium	klein	Medium	groß
10-1704-03	Large	petit	moyen	grand
		pequeño	medio	grande



**Cobb**

10-1706-01	Small	Small	Medium	Large
10-1706-02	Medium	klein	Medium	groß
10-1706-03	Large	petit	moyen	grand
		pequeño	medio	grande



**Mitchell**

10-1707-18  
10-1707-20  
38mm

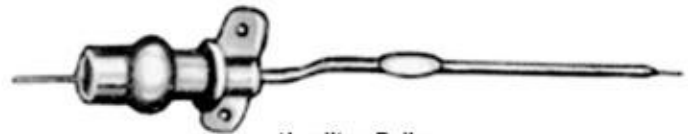

**Hamilton Bailey**

10-1708-01	Infant	Infant	Child	Adult
10-1708-02	Child	Säugling	Kind	Erwachsene
10-1708-03	Adult	nourrison	enfant	adulte
		infantil	niño	adulto

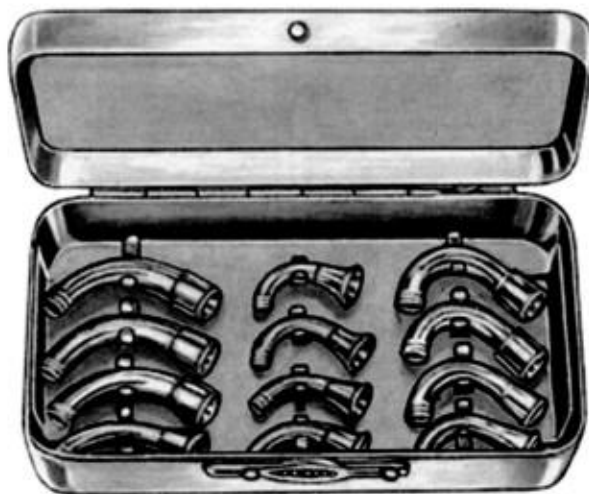

**Magill**

Connexion Set  
09-1709-00



**Magill (Nasal)**

	mm dia
10-1710-01	5.5
10-1710-02	6.5
10-1710-03	7.5
10-1710-04	8.0
10-1710-05	8.5
10-1710-06	9.5
10-1710-07	10.0
10-1710-08	10.5

**Magill (Nasal)**

	mm dia
10-1711-01	5.5
10-1711-02	6.5
10-1711-03	7.5
10-1711-04	8.0
10-1711-05	8.5
10-1711-06	9.5
10-1711-07	10.0
10-1711-08	10.5