



WITTEX INTERNATIONAL

— MANUFACTURERS & EXPORTERS OF SINGLE USE INSTRUMENTS —

SINGLE USE INSTRUMENTS



PREMIUM QUALITY
AISI STAINLESS STEEL



EXCEPTIONAL
DURABILITY



PRECISE
PERFORMANCE



www.wittex.com

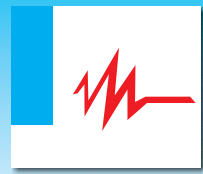

WITTEX
INTERNATIONAL

Manufacturers & Exporters of Single Use Instruments

NEEDLE HOLDER FORCEPS

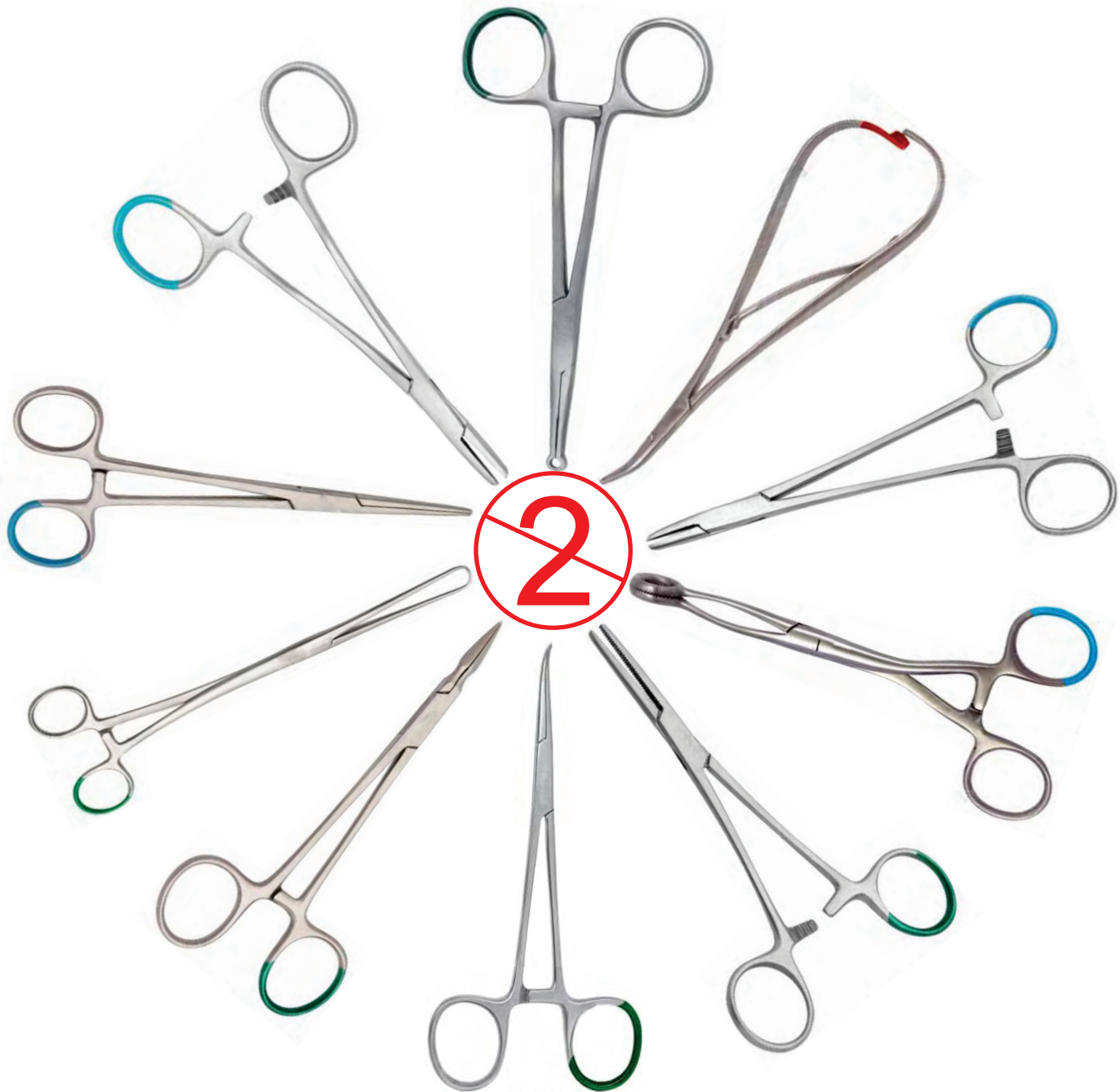

 www.wittex.com

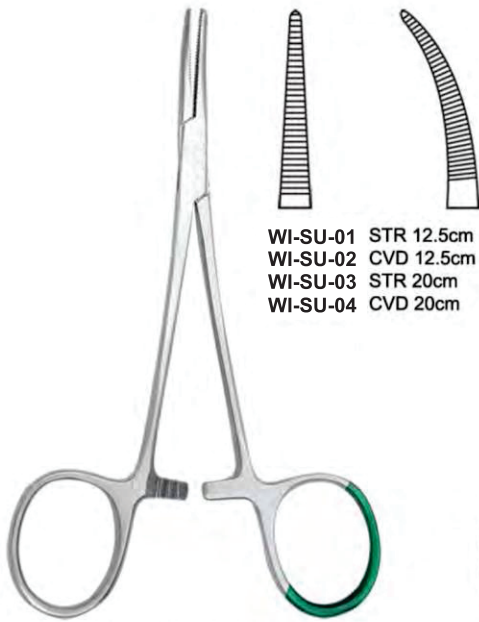

WI-SU-01 STR 12.5cm
 WI-SU-02 CVD 12.5cm
 WI-SU-03 STR 20cm
 WI-SU-04 CVD 20cm

**HALSTED MOSQUITO
ARTERY FORCEPS**



WI-SU-05 12.5cm
 WI-SU-06 14cm
 WI-SU-07 15cm
 WI-SU-08 16cm
 WI-SU-09 18.5cm
 WI-SU-10 18cm
 with Hole

MAYO-HEGAR NEEDLE HOLDER (MEDIUM)

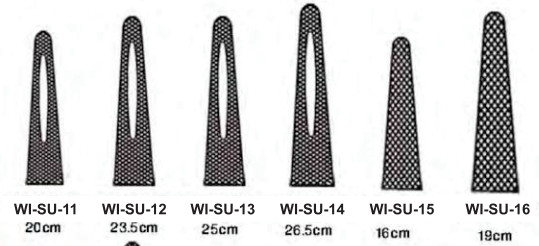

WI-SU-11 20cm
 WI-SU-12 23.5cm
 WI-SU-13 25cm
 WI-SU-14 26.5cm
 WI-SU-15 16cm
 WI-SU-16 19cm



WI-SU-17
15cm

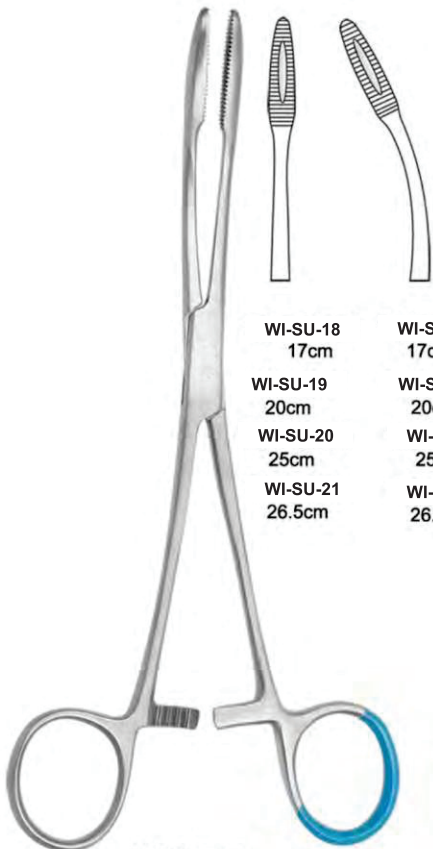

WI-SU-18 17cm
 WI-SU-19 20cm
 WI-SU-20 25cm
 WI-SU-21 26.5cm
 WI-SU-22 17cm
 WI-SU-23 20cm
 WI-SU-24 25cm
 WI-SU-25 26.5cm

**GROSS MAIER
SPONGE FORCEPS**

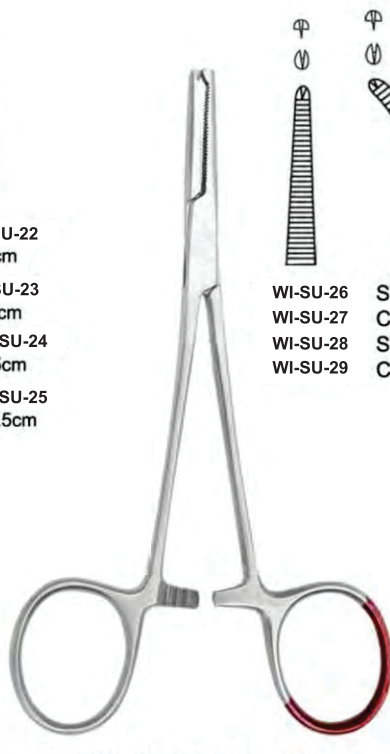

WI-SU-26 STR 12.5cm
 WI-SU-27 CVD 12.5cm
 WI-SU-28 STR 20cm
 WI-SU-29 CVD 20cm

**HALSTED MOSQUITO KOCHER FORCEPS
1X2 Teeth**



WI-SU-30
**PEAN ARTERY FORCEPS
TUBING CLUMP
12.5cm**

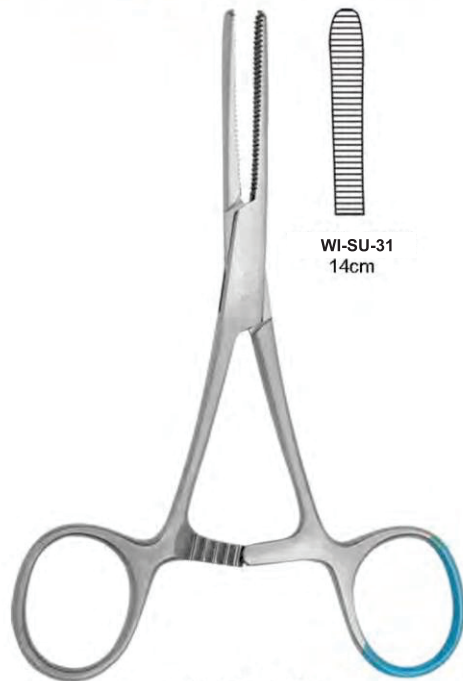

WI-SU-31
14cm

TUBING CLAMP
HEAVY PATTERN LONG RATCHET
KLINIKUM BERLIN



PEAN KOCHER FORCEPS

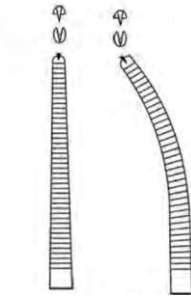

- WI-SU-32 CVD 13cm
- WI-SU-32 STR 13cm
- WI-SU-33 STR 14cm
- WI-SU-34 CVD 14cm
- WI-SU-35 STR 15cm
- WI-SU-36 CVD 15cm
- WI-SU-37 STR 16cm
- WI-SU-38 CVD 16cm
- WI-SU-39 STR 18.5cm
- WI-SU-40 CVD 18.5cm
- WI-SU-41 STR 20cm
- WI-SU-42 CVD 20cm
- WI-SU-43 STR 22.5cm
- WI-SU-44 CVD 22.5cm
- WI-SU-45 STR 24cm
- WI-SU-46 CVD 24cm
- WI-SU-47 STR 26cm
- WI-SU-48 CVD 26cm
- WI-SU-49 STR 28cm
- WI-SU-50 CVD 28cm
- WI-SU-51 STR 35cm
- WI-SU-52 CVD 35cm



WI-SU-53

DERF NEEDLE HOLDER
12.5cm



ROCHESTER PEAN FORCEPS

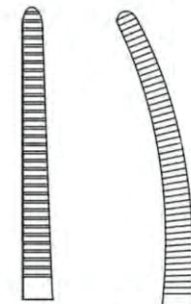

- WI-SU-54 STR 13cm
- WI-SU-55 CVD 13cm
- WI-SU-56 STR 14cm
- WI-SU-57 CVD 14cm
- WI-SU-58 STR 16cm
- WI-SU-59 CVD 16cm
- WI-SU-60 STR 18cm
- WI-SU-61 CVD 18cm
- WI-SU-62 STR 20cm
- WI-SU-63 CVD 20cm
- WI-SU-64 STR 22.5mm
- WI-SU-65 CVD 22.5mm
- WI-SU-66 STR 24cm
- WI-SU-67 CVD 24cm
- WI-SU-68 STR 26.5cm
- WI-SU-69 CVD 26.5cm
- WI-SU-70 STR 35cm
- WI-SU-71 CVD 35cm
- WI-SU-72 STR 14cm

MEDIUM

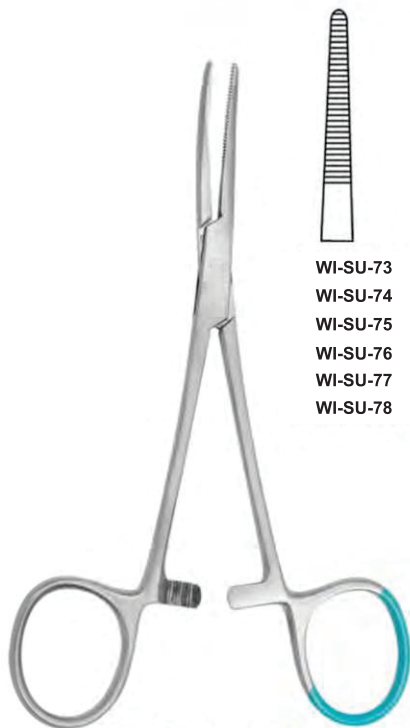

KELLY FORCEPS

- | | | |
|----------|-----|--------|
| WI-SU-73 | STR | 14cm |
| WI-SU-74 | CVD | 14cm |
| WI-SU-75 | STR | 16cm |
| WI-SU-76 | CVD | 16cm |
| WI-SU-77 | STR | 12.5cm |
| WI-SU-78 | CVD | 12.5cm |

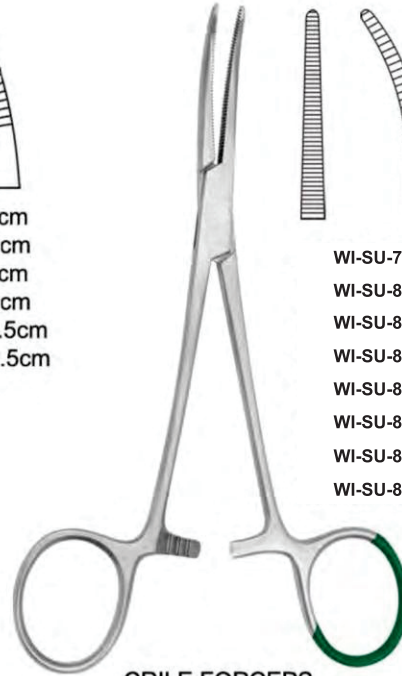

CRILE FORCEPS

- | | |
|----------|--------------------|
| WI-SU-79 | 14cm STR |
| WI-SU-80 | 14cm CVD |
| WI-SU-81 | 16cm STR |
| WI-SU-82 | 16cm CVD |
| WI-SU-83 | 14cm STR 1X2 TEETH |
| WI-SU-84 | 14cm CVD 1X2 TEETH |
| WI-SU-85 | 16cm STR 1X2 TEETH |
| WI-SU-86 | 16cm CVD 1X2 TEETH |



BABCOCK ORGAN & TISSUE GRASPING FORCEPS

- | | |
|----------|--------|
| WI-SU-88 | 15.5cm |
| WI-SU-89 | 17cm |
| WI-SU-91 | 21.5cm |
| WI-SU-92 | 20cm |



GROSS SPONGE FORCEPS

WI-SU-87
18cm



CRAFOORD ARTERY FORCEPS (MODIFIED)

WI-SU-93 CVD 24cm

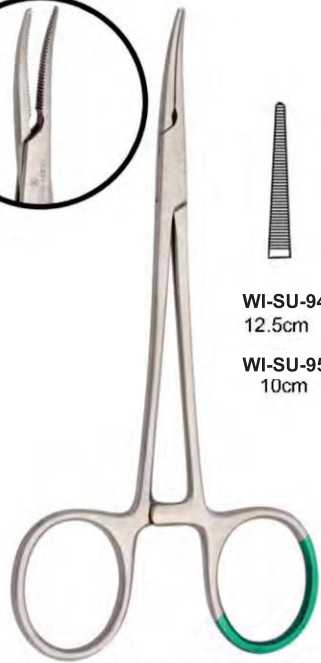

MICRO MOSQUITO FORCEPS

WI-SU-94 12.5cm	WI-SU-96 12.5cm
WI-SU-95 10cm	WI-SU-97 10cm



MICRO MOSQUITO KOCHER FORCEPS
1X2 Teeth

WI-SU-98 12.5cm	WI-SU-100 12.5cm
WI-SU-99 10cm	WI-SU-101 10cm



STIEGLITZ SPLINTER FORCEPS
14cm

WI-SU-102
CVD

WI-SU-103
STR



BACKHAUS TOWEL CLAMP

WI-SU-104 9cm	WI-SU-105 11cm	WI-SU-106 13.5cm
------------------	-------------------	---------------------



TUBING CLUMP FORCEPS
WI-SU-119 16.5cm HEAVY
TUBING CLUMP FORCEPS
WI-SU-120 16.5cm LIGHT WEIGHT

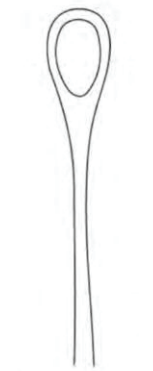

SMOOTH JAWS
WI-SU-107
24.5cm



WI-SU-108
18cm
WI-SU-109
24.5cm
WI-SU-110
25.5cm
WI-SU-111
32cm

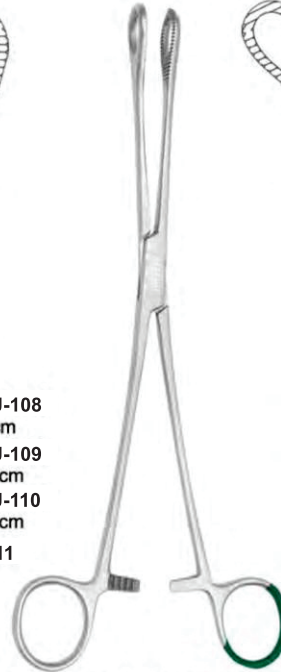

FOERSTER SPONGE HOLDING FORCEPS



WI-SU-112
18cm
WI-SU-113
24.5cm
WI-SU-114
25.5cm
WI-SU-115
32cm

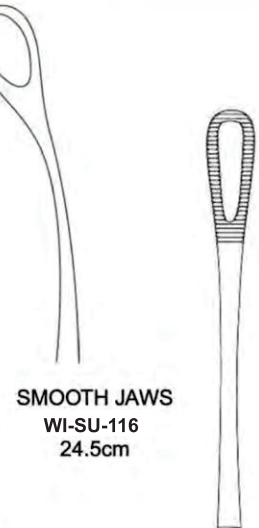

SMOOTH JAWS
WI-SU-116
24.5cm

WI-SU-117 18cm
WI-SU-118 25cm

RAMPLEY SPONGE FORCEPS



TUBING CLUMP FORCEPS
WI-SU-126 18cm
WI-SU-127 15cm

WI-SU-124 18cm
WI-SU-125 20cm
SERRATED JAW WITH OUT CLIP



MAGILL FORCEPS



WI-SU-121
15cm



WI-SU-122
20cm



WI-SU-123
25cm

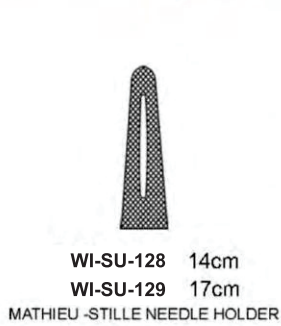

MATHIEU NEEDLE HOLDER

MATHIEU NEEDLE HOLDER

WI-SU-130	14cm
WI-SU-131	15cm
WI-SU-132	17cm
WI-SU-133	20cm



SMAHA MATHIEU MOSQUITO
FINE POINT

WI-SU-134	14cm
WI-SU-135	17cm
WI-SU-136	20cm



SMAHA MATHIEU MOSQUITO
FINE POINT CVD

WI-SU-137	14cm
WI-SU-138	17cm
WI-SU-139	20cm



OLSEN-HEGAR NEEDLE HOLDER

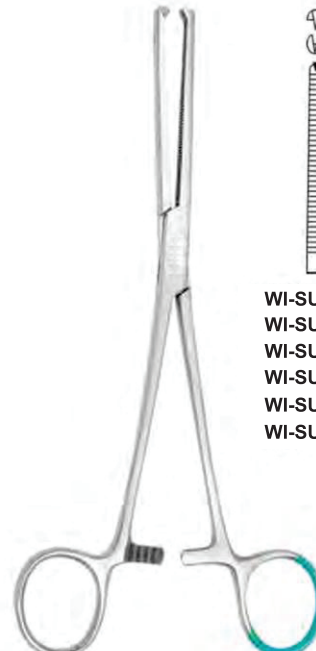
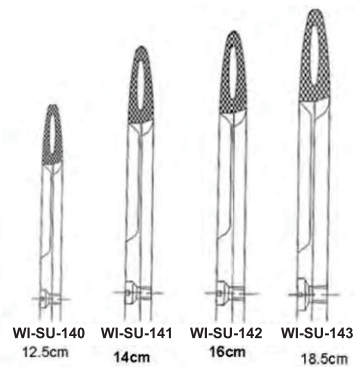

ROCHESTER-OCHSNER FORCEPS
1X2 Teeth

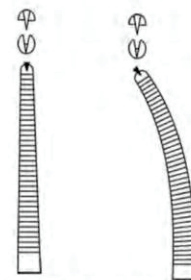

WI-SU-144	TABH 6199	14cm
WI-SU-145	TABH 6433	16cm
WI-SU-146	TABH 6455	18cm
WI-SU-147	TABH 6477	20cm
WI-SU-148	TABH 6499	22.5cm
WI-SU-149	TABH 6511	24cm

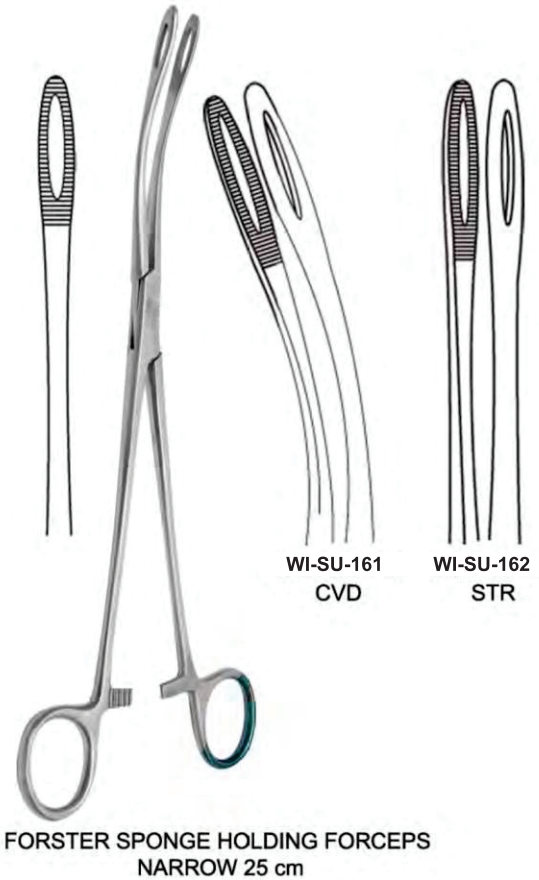
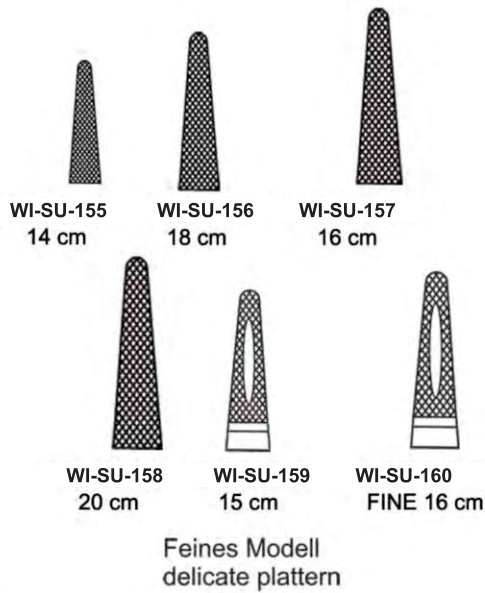
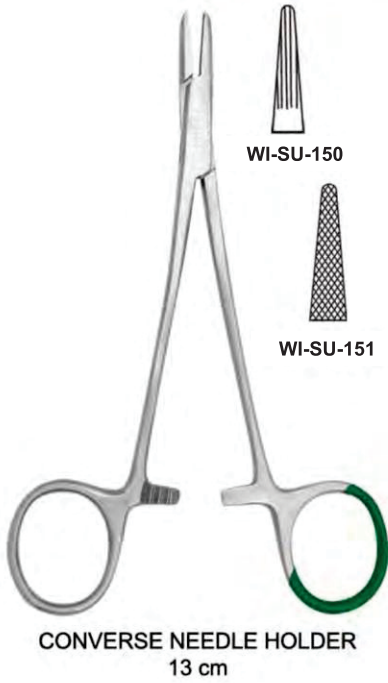



PEAN DRESSING FORCEPS

- WI-SU-163 12.5cm STR
- WI-SU-164 12.5cm CVD
- WI-SU-165 14cm STR
- WI-SU-166 14cm CVD
- WI-SU-167 16cm STR
- WI-SU-168 16cm CVD

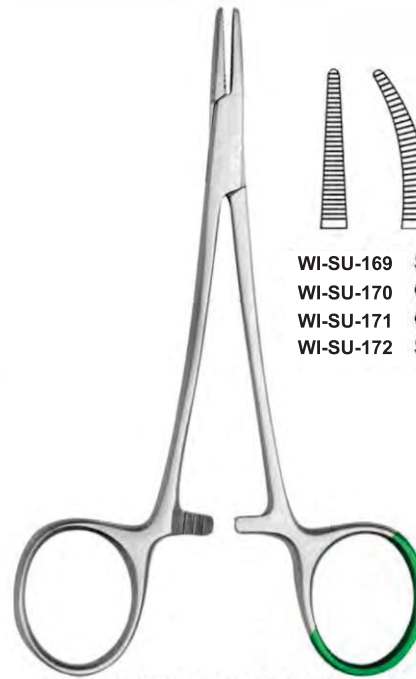

BABY CRILE ARTERY FORCEPS
14cm

- WI-SU-169 STR
- WI-SU-170 CVD
- WI-SU-171 CVD (KOCHER)
- WI-SU-172 STR (KOCHER)



ULRICH DRESSING FORCEPS

- WI-SU-176 22cm STR
- WI-SU-177 22cm CVD
- WI-SU-178 26.5cm STR
- WI-SU-179 26.5cm CVD

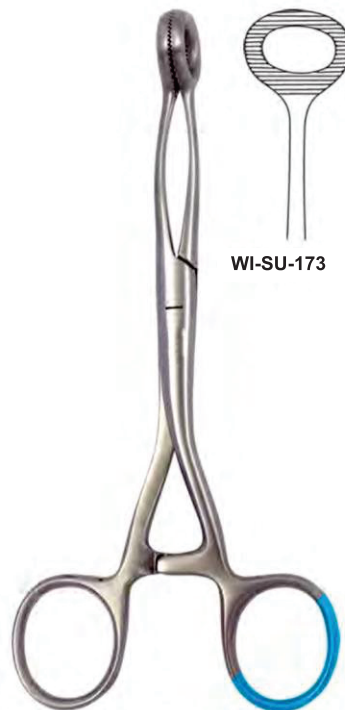

COLLIN HEMOSTATIC FORCEPS
17cm

WI-SU-173



CRILE-MURRAY NEEDLE HOLDER

- WI-SU-174 15cm
- WI-SU-175 16cm

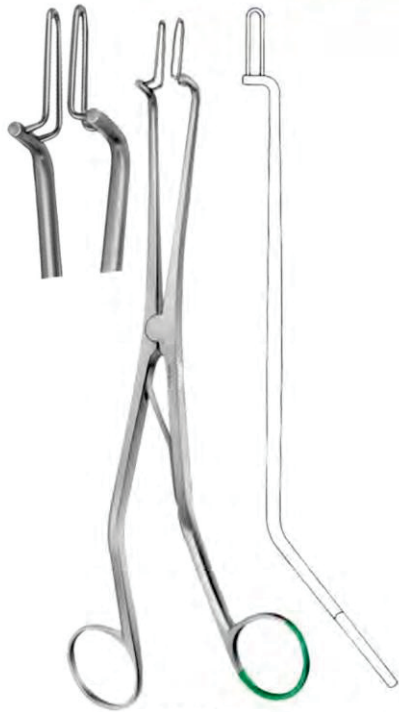

WI-SU-180
KOGAN CERVIX SPECULA,
WITH OUT RATCHET 24cm



WI-SU-181
BABY CRILE WOOD NEEDLE HOLDER
15cm



WI-SU-182
MICHEL CLIP APPLYING &
REMOVING FORCEPS
12.5cm



WI-SU-183 17.5cm
WI-SU-184 25.5cm
POZZI UTERINE
TENACULUM FORCEPS
STRAIGHT



WI-SU-185
SCHROEDER UTERINE
DRESSING FORCEPS,
STRAIGHT 25cm



WI-SU-186
COLLIN-POZZI UTERINE
DRESSING FORCEPS
STRAIGHT 25cm

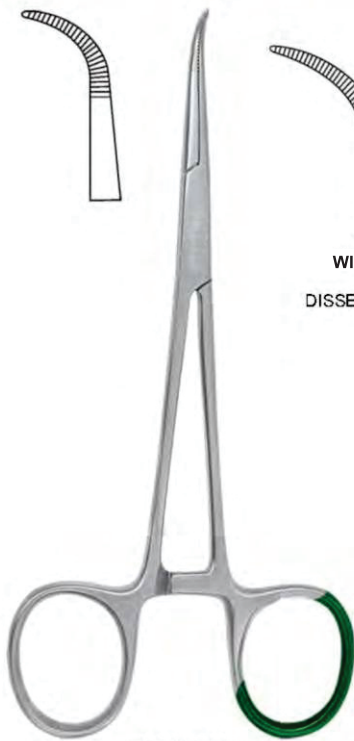

WI-SU-190
MICRO ADSON DISSECTING
FORCEPS CVD 14cm

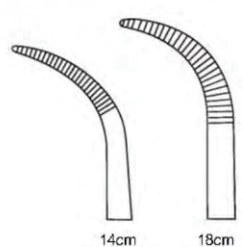

14cm 18cm
WI-SU-187 WI-SU-188
BABY MIXTER
DISSECTING FORCEPS CVD



WI-SU-191 STR
BIRKETT ARTERY FORCEPS
18.5cm



WI-SU-189 CVD



WI-SU-192
LERICHE ARTERY FORCEPS
15cm



WI-SU-193
BABY OVERHOLT FORCEPS
CVD 135 mm



WI-SU-194 CVD
SCHNIDT ARTERY FORCEPS
19cm



WI-SU-195 15.5cm 3X4 TEETH
WI-SU-196 15.5cm 4X5 TEETH
WI-SU-197 15.5cm 5X6 TEETH
WI-SU-198 20cm 6X7 TEETH
ALLIS TISSUE GRASPING FORCEPS



WI-SU-199 13cm LIGHT WEIGHT
TAF 0077 14CM STRONG PATTERN
LABORDE TRACHEAL DILATOR DOUBLE SPRING



WI-SU-200 28cm
CHEATLE STERILIXING FORCEPS



WI-SU-201
TRACHEAL DILATOR TROUSSEAU
12cm



WI-SU-202
LIGHT

WI-SU-203
VERY DELICATE



CRILE WOOD NEEDLE HOLDER
14cm



WI-SU-204 13.5cm
WI-SU-205 14cm



KILNER NEEDLE HOLDER



WI-SU-206 11.5cm
WI-SU-207 14cm
TOWEL CLAMP for PAPER CLOTHS



SPENCER WELLS ARTERY FORCEPS

- WI-SU-208 STR 13cm
- WI-SU-209 CVD 13cm
- WI-SU-210 STR 15cm
- WI-SU-211 CVD 15cm
- WI-SU-212 STR 17cm
- WI-SU-213 CVD 17cm
- WI-SU-214 STR 20cm
- WI-SU-215 CVD 20cm
- WI-SU-216 STR 23cm
- WI-SU-217 CVD 23cm



WI-SU-218
QUIRE EAR FORCEPS
FOR REMOVAL OF FOREIGN BODIES 9cm



WI-SU-219

CASTROVIEJO NEEDLE HOLDER
14cm STR with catch



WI-SU-220 STR 16cm
WI-SU-221 CVD 16cm

MICRO NEEDLE HOLDER
With out catch



WI-SU-222 STR

NOYES EYE SCISSORS 12.5cm
TAOC 4822/1 CVD



WI-SU-223 CVD
VASECTOMY FINE MOSQUITO FORCEPS
12.5cm



WI-SU-224 N DIA 4.7MM
WI-SU-225 N DIA 3.0MM
VASECTOMY RING FORCEPS
RING FINE 14cm



WI-SU-226
DIXON-LOVELACE FORCEPS
STR 16cm



COLLIN ORGAN GRASPING FORCEPS
WI-SU-227 STR 27cm
WI-SU-228 CVD 27cm
WI-SU-229 CVD 24cm
WI-SU-230 STR 24cm



WI-SU-231
PELKMANN FOREIGN
BODY REMOVAL FORCEPS
STR 26CM



WI-SU-232
DIXON-LOVELACE KOCHER FORCEPS
1X2 TEETH STR 16cm

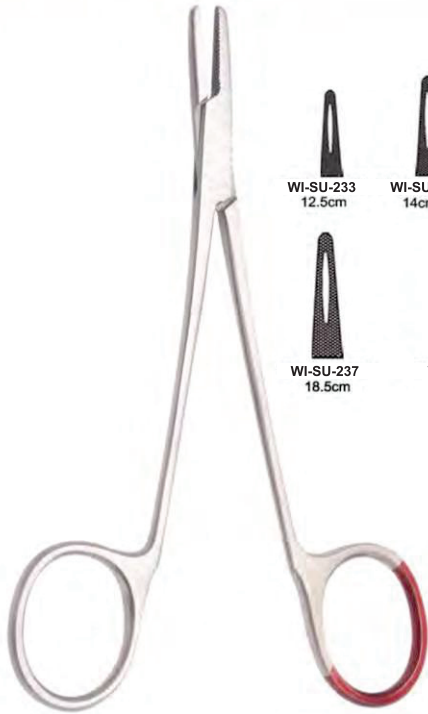

**MAYO HEGAR NEEDLE HOLDER WITH OUT LOCK
SPECIAL MODEL**



**WI-SU-240
ROBERTS ARTERY FORCEPS
STR 22.5cm**



**WI-SU-244
BOZEMANN FORCEPS
25cm**



**WI-SU-245
BOZEMANN-DOUGLAS FORCEPS
26cm**

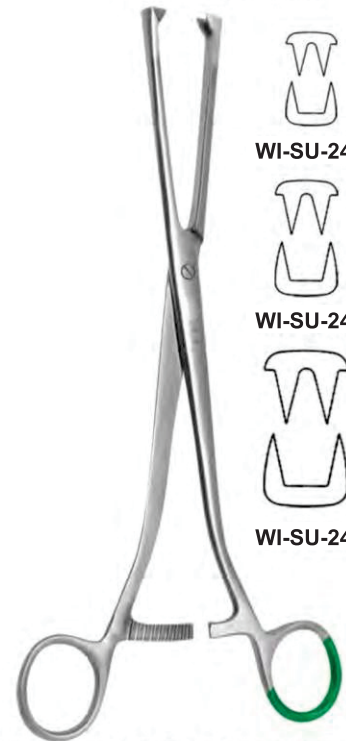

**MUSEUX UTRTINE DRESSING FORCEPS
STR, TOOTHED 2X2
SCREW LOCK 24cm**





WITTEX
INTERNATIONAL

Manufacturers & Exporters of Single Use Instruments

SCISSORS

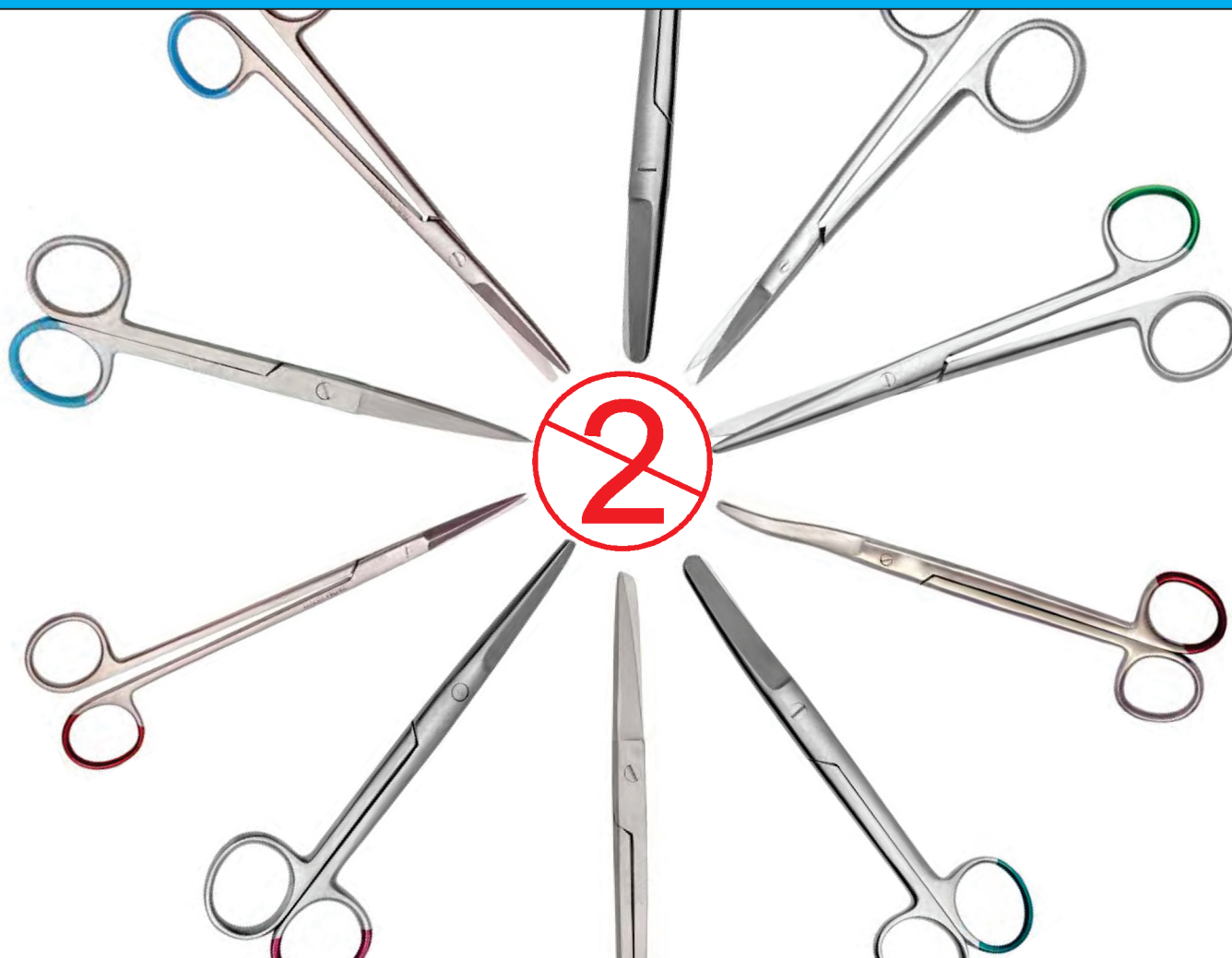

 www.wittex.com



WI-SU-246 11.5cm WI-SU-247 14cm WI-SU-248 15cm WI-SU-249 18cm WI-SU-250 20cm

LISTER BANDAGE SCISSORS



SURGICAL SCISSORS SH /BL

- WI-SU-251 STR 10cm
- WI-SU-252 CVD 10cm
- WI-SU-253 STR 11cm
- WI-SU-254 CVD 11cm
- WI-SU-255 STR 12cm
- WI-SU-256 CVD 12cm
- WI-SU-257 STR 13cm
- WI-SU-258 CVD 13cm
- WI-SU-259 STR 14cm
- WI-SU-260 CVD 14cm
- WI-SU-261 STR 15cm
- WI-SU-262 CVD 15cm
- WI-SU-263 STR 16cm
- WI-SU-264 CVD 16cm
- WI-SU-265 STR 17cm
- WI-SU-266 CVD 17cm
- WI-SU-267 STR 18cm
- WI-SU-268 CVD 18cm
- WI-SU-269 STR 20cm



IRIS & LIGATURE SCISSORS

- WI-SU-270 STR 9cm
- WI-SU-271 CVD 9cm
- WI-SU-272 STR 10cm
- WI-SU-273 CVD 10cm
- WI-SU-274 STR 11cm
- WI-SU-275 CVD 11cm
- WI-SU-276 STR 11cm
- WI-SU-277 CVD 11cm
- WI-SU-278 STR 12cm
- WI-SU-279 CVD 12cm
- WI-SU-280 STR 13cm
- WI-SU-281 CVD 13cm

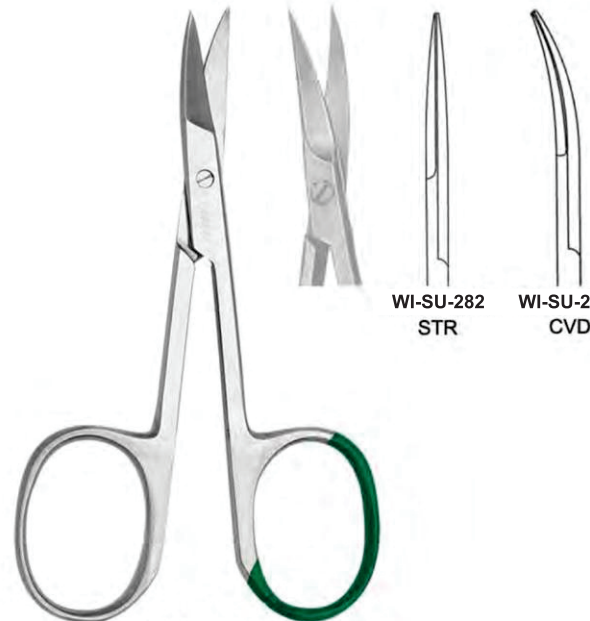

DELICATE SCISSORS
9cm

WI-SU-282 STR WI-SU-283 CVD



SURGICAL SCISSORS Blunt /Blunt

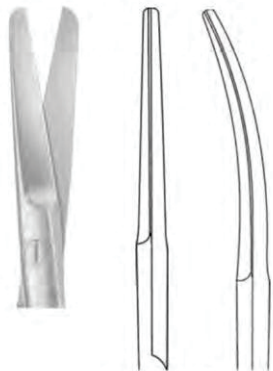

- WI-SU-284 STR 11.5cm
- WI-SU-285 CVD 11.5cm
- WI-SU-286 STR 13cm
- WI-SU-287 CVD 13cm
- WI-SU-288 STR 14cm
- WI-SU-289 CVD 14cm
- WI-SU-290 STR 15cm
- WI-SU-291 CVD 15cm
- WI-SU-292 STR 16cm
- WI-SU-293 CVD 16cm
- WI-SU-294 STR 17.5cm
- WI-SU-295 CVD 17.5cm
- WI-SU-296 STR 18cm
- WI-SU-297 CVD 18cm



SURGICAL SCISSORS Sharp /Sharp

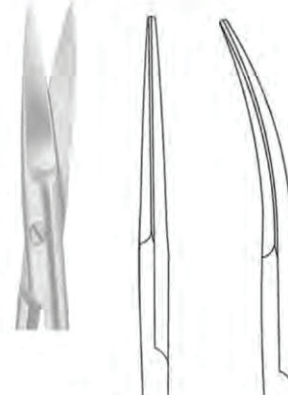

- WI-SU-298 STR 11.5cm
- WI-SU-299 CVD 11.5cm
- WI-SU-300 STR 13cm
- WI-SU-301 CVD 13cm
- WI-SU-302 STR 14cm
- WI-SU-303 CVD 14cm
- WI-SU-304 STR 15cm
- WI-SU-305 CVD 15cm
- WI-SU-306 STR 16cm
- WI-SU-307 CVD 16cm



SPENCER / STITCH / SUTURE SCISSORS

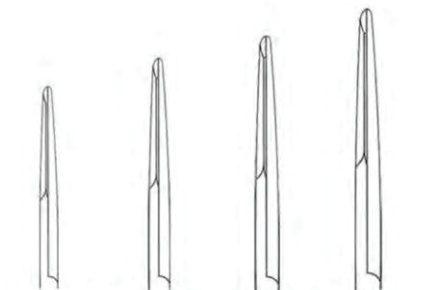

- WI-SU-308 9cm
- WI-SU-309 11.5cm
- WI-SU-310 13cm
- WI-SU-311 14cm



REYNOLDS / STEVENS / JAMESON DISSECTING SCISSORS FINE (SHARP)

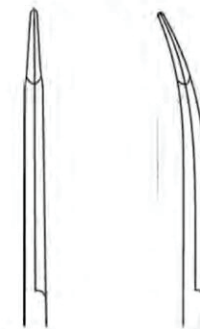

- WI-SU-312 10.5cm
- WI-SU-313 11.5cm
- WI-SU-314 12.5cm
- WI-SU-315 15cm
- WI-SU-316 15cm (BLUNT)
- WI-SU-317 10.5cm
- WI-SU-318 11.5cm
- WI-SU-319 12.5cm
- WI-SU-320 13cm
- WI-SU-321 15cm
- WI-SU-322 14cm
- WI-SU-323 17.5cm



WI-SU-324 13cm
WI-SU-325 16cm
WI-SU-326FS 13cm
WI-SU-327FS 16cm
FLAT SHAPE

**UMBILICAL CORD SCISSORS
(BUSCH) SIDEWARDS CVD**



**METZENBAUM (fino) DISSECTING
SCISSORS**

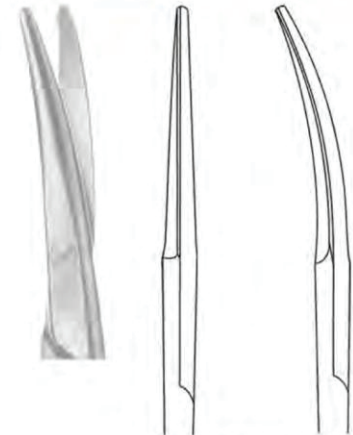

WI-SU-328 STR 11.5cm
WI-SU-329 CVD 11.5cm
WI-SU-330 STR 12.5cm
WI-SU-331 CVD 12.5cm
WI-SU-332 STR 14cm
WI-SU-333 CVD 14cm
WI-SU-334 STR 15cm
WI-SU-335 CVD 15cm
WI-SU-336 STR 16cm
WI-SU-337 CVD 16cm
WI-SU-338 STR 18cm
WI-SU-339 CVD 18cm
WI-SU-340 STR 20cm
WI-SU-341 CVD 20cm
WI-SU-342 STR 23cm
WI-SU-343 CVD 23cm
WI-SU-344 STR 25cm
WI-SU-345 CVD 25cm



WI-SU-346 CVD 13cm
WI-SU-347 CVD 15cm
**KILNER SCISSORS SPECIAL FLAT POINT
for DISSECTING & UNDERMINING THE SKIN**



**EPISIOTOMY (WALDMANN)
SCISSORS**



WI-SU-348 18cm
WI-SU-349 20cm
WI-SU-350 24cm



**WI-SU-351
SCHUHMACHER
UMBILICAL CORD SCISSORS
15.5cm**



WI-SU-352 16cm
WI-SU-353 18cm

**DOYEN HEAVY SCISSORS
STR**



WI-SU-354 16cm
WI-SU-355 18cm

**DOYEN HEAVY SCISSORS
CVD**



WI-SU-356 14cm STR
WI-SU-357 14cm CVD
WI-SU-358 16cm STR
WI-SU-359 16cm CVD

**DRESSING / INCISION / SCISSORS
WITH PROBE POINTED FLATE SHAPE**



**BRAUN-STADLER
(EPISITOMY SCISSORS)**



WI-SU-360
14cm



WI-SU-361
20cm



WI-SU-362
SET OF 3 PCS
NAIL SCISSORS 9cm
NAIL FILE 9CM & HANGING CHAIN



WIRE CUTTING SCISSORS
12cm
WI-SU-363



WI-SU-364
13cm
TWO NOTCHES HEAVY SCISSORS



WI-SU-365
MAYO HARRINGTON DISSECTING SCISSORS CVD
18cm

WI-SU-366
MAYO HARRINGTON DISSECTING SCISSORS CVD
23cm

WI-SU-367
MAYO HARRINGTON DISSECTING SCISSORS STR
18cm
TABC5600
MAYO HARRINGTON DISSECTING SCISSORS STR
23cm



WI-SU-369 #1 BOETTCHER SCISSORS
18cm STR
WI-SU-370 BOETTCHER SCISSORS
18cm CVD



MAYO-SCISSORS

WI-SU-371 STR 14cm
 WI-SU-372 CVD 14cm
 WI-SU-373 STR 15.5cm
 WI-SU-374 CVD 15.5cm
 WI-SU-375 STR 16.5cm
 WI-SU-376 CVD 16.5cm
 WI-SU-377 STR 17cm
 WI-SU-378 CVD 17cm
 WI-SU-379 STR 20cm
 WI-SU-380 CVD 20cm
 WI-SU-381 STR 21cm
 WI-SU-382 /1 CVD 21cm

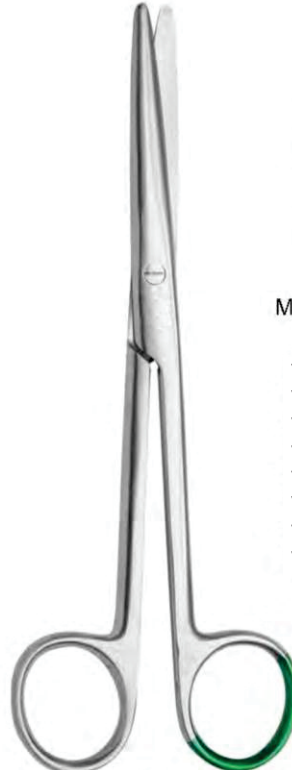

MAYO-LEXER SCISSORS

**MAYO-LEXER SCISSORS
(FINO)**

WI-SU-383 /14 STR 14cm
 WI-SU-384 /14 CVD 14cm
 WI-SU-385 / STR 16.5cm
 WI-SU-386 CVD 16.5cm
 WI-SU-387 / STR 17cm
 WI-SU-388 / CVD 17cm
 WI-SU-389 / STR 20cm
 WI-SU-390 / CVD 20cm

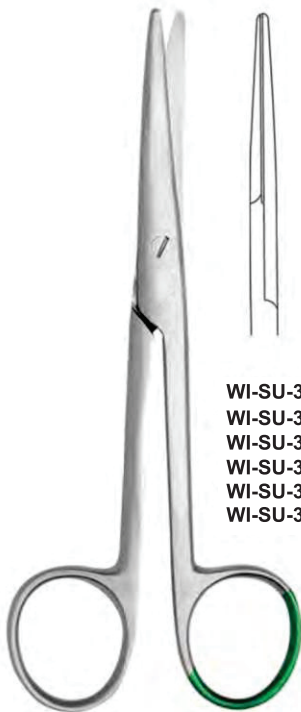

MAYO-STILLE SCISSORS

WI-SU-391 STR 14cm
 WI-SU-392 CVD 14cm
 WI-SU-393 STR 15cm
 WI-SU-394 CVD 15cm
 WI-SU-395 STR 17cm
 WI-SU-396 CVD 17cm



**WI-SU-397
UMBILICAL CORD SCISSORS SIDEWARDS
20cm**



**WI-SU-398
FUNNY SCISSORS
20cm**

FLAT SHAPE SCISSORS



WI-SU-399	/FS	STR	11.5cm
WI-SU-400	/FS	CVD	11.5cm
WI-SU-401	/FS	STR	13cm
WI-SU-402	/FS	CVD	13cm
WI-SU-403	/FS	STR	14cm
WI-SU-404	/FS	CVD	14cm
WI-SU-405	/FS	STR	15cm
WI-SU-406	/FS	CVD	15cm
WI-SU-407	/FS	STR	16cm
WI-SU-408	/FS	CVD	16cm

SURGICAL SCISSORS SH/SH FLAT SHAPE



WI-SU-409	/FS	STR	10.5cm
WI-SU-410	/FS	CVD	10.5cm
WI-SU-411	/FS	STR	11cm
WI-SU-412	/FS	CVD	11cm
WI-SU-413	/1/FS	STR	12cm
WI-SU-414	/1/FS	CVD	12cm
WI-SU-415	/1/FS	STR	13cm
WI-SU-416	/FS	STR	13cm
WI-SU-417	/FS	CVD	13cm
WI-SU-418	/FS	STR	14cm
WI-SU-419	/FS	CVD	14cm
WI-SU-420	/FS	STR	15cm
WI-SU-421	/FS	CVD	15cm
WI-SU-422	/FS	STR	16cm
WI-SU-423	/FS	CVD	16cm
WI-SU-424	/FS	STR	17cm
WI-SU-425	/FS	CVD	17cm
WI-SU-426	/FS	STR	18.5cm
WI-SU-427	/FS	CVD	18.5cm
WI-SU-428	/FS	STR	20cm

SURGICAL SCISSORS SH/BL FLAT SHAPE



WI-SU-429	/FS	STR	11.5cm
WI-SU-430	/FS	CVD	11.5cm
WI-SU-431	/FS	STR	13cm
WI-SU-432	/FS	CVD	13cm
WI-SU-433	/FS	STR	14cm
WI-SU-434	/FS	CVD	14cm
WI-SU-435	/FS	STR	15cm
WI-SU-436	/FS	CVD	15cm
WI-SU-437	/FS	STR	16cm
WI-SU-438	/FS	CVD	16cm
WI-SU-439	/FS	STR	17cm
WI-SU-440	/FS	CVD	17cm
WI-SU-441	/FS	STR	18cm
WI-SU-442	/FS	CVD	18cm

SURGICAL SCISSORS BL/BL FLAT SHAPE



WI-SU-443	/FS	STR	9cm
WI-SU-444	/FS	CVD	9cm
WI-SU-445	/FS	STR	10cm
WI-SU-446	/FS	CVD	10cm
WI-SU-447	/FS	STR	11cm
WI-SU-448	/FS	CVD	11cm
WI-SU-449	/FS	CVD	11cm
WI-SU-450	/FS	STR	11cm
WI-SU-451	/FS	CVD	11cm
WI-SU-452	/FS	STR	12cm
WI-SU-453	/FS	CVD	12cm
WI-SU-454	/FS	STR	13cm
WI-SU-455	/FS	STR	13cm
WI-SU-456	/FS	CVD	13cm

IRIS SCISSORS SH/SH FLAT SHAPE



WI-SU-457 straight, bluntblunt.
TOENNIS Dissecting Scissors,
18CM



WI-SU-458 curved, blunt blunt
TOENNIS Dissecting Scissors,
18CM

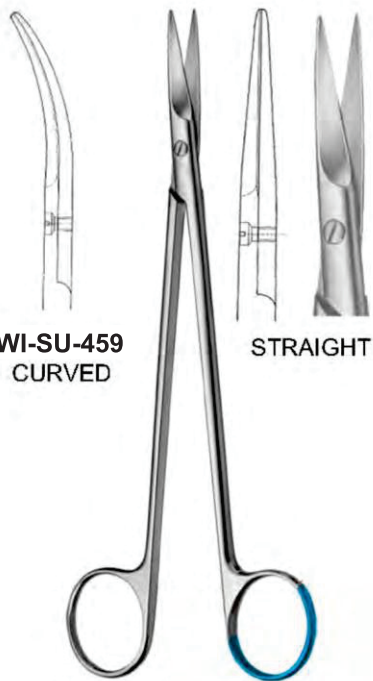

WI-SU-459
CURVED

STRAIGHT

WI-SU-462 delicate
TOENNIS Dissecting Scissors,
blunt/blunt, 18CM

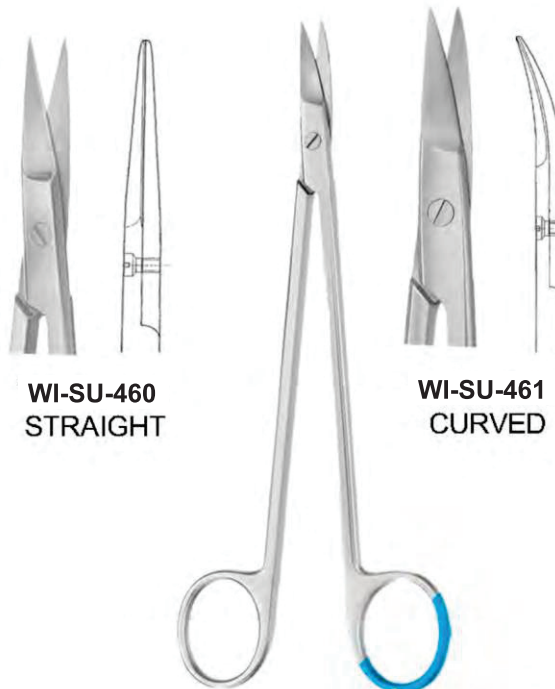

WI-SU-460
STRAIGHT

WI-SU-461
CURVED

KELLY Dissecting Scissors,
sharp sharp
17CM



WITTTEX
INTERNATIONAL

Manufacturers & Exporters of Single Use Instruments

TWEEZERS



 www.witttex.com



WI-SU-463 STR 180mm
WI-SU-464 STR 200mm
WI-SU-465 CVD 200mm
WI-SU-466 STR 250mm

CUSHING DISSECTING FORCEPS

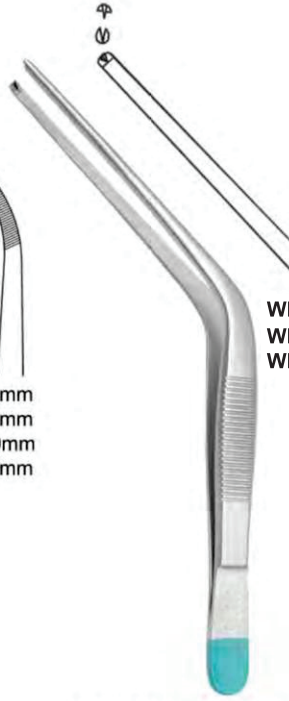

WI-SU-467 115 mm
WI-SU-468 140 mm
WI-SU-469 170 mm

TROELTSCH TISSUE FORCEPS
1X2 Teeth

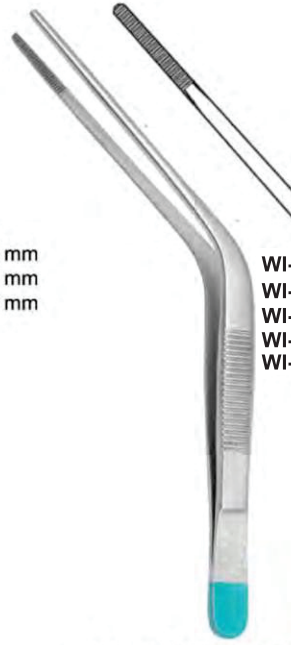

WI-SU-470 100 mm
WI-SU-471 115 mm
WI-SU-472 140 mm
WI-SU-473 170 mm
WI-SU-474 150 mm

TROELTSCH FORCEPS



FEILCHENFELD
SPLINTER FORCEPS

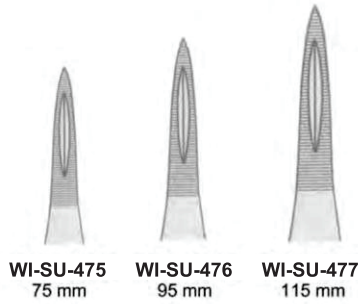

WI-SU-475 75 mm
WI-SU-476 95 mm
WI-SU-477 115 mm



WI-SU-481
75 mm FINE



WI-SU-478
MICRO ADSON
150mm



WI-SU-482
(STANDARD)
150mm



WI-SU-479
120mm
(Standard)

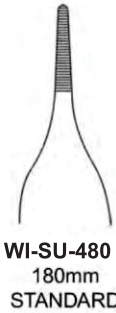

WI-SU-480
180mm
STANDARD



WI-SU-483
120mm
MICRO ADSON



ADSON FORCEPS



- WI-SU-484 115 mm
- WI-SU-485 /1 125mm
- WI-SU-486 130 mm
- WI-SU-487 145 mm
- WI-SU-488 160 mm
- WI-SU-489 180 mm
- WI-SU-490 200 mm
- WI-SU-491 250 mm
- WI-SU-492 300 mm
- WI-SU-493 /1 350 mm
- WI-SU-494 /1 400 mm
- WI-SU-495 /1 450 mm
- WI-SU-496 /1 550 mm

DRESSING FORCEPS(TWEEZERS)
STANDARD STR, SERRATED



- WI-SU-497 115 mm
- WI-SU-498 /1 125mm
- WI-SU-499 130 mm
- WI-SU-500 145 mm
- WI-SU-501 160 mm
- WI-SU-502 180 mm
- WI-SU-503 200 mm
- WI-SU-504 250 mm
- WI-SU-505 300 mm

DRESSING FORCEPS(TWEEZERS)
MEDIUM STR, SERRATED



WI-SU-506
85 mm

BISHOP-HARMON EYE FORCEPS
1X2 TEETH



WI-SU-508
LONDON COLLEGE TWEEZERS
SERRATED WITH LOCK 15CM



WI-SU-509 150 mm
TADA 2433 150 mm
LONDON-COLLEGE TWEEZER
ANGLED, SERRATED



WI-SU-510 160mm
TOOTH TWEEZER
ANGLED,ERRATED



MERIAM TWEEZER ANGLED,
WI-SU-511 : SMOOTH 150mm
WI-SU-512 /1 SERRATED 150mm
WI-SU-513 : SERRATED 160mm
WI-SU-514 /1 SMOOTH 160mm



WI-SU-515
MC INDOE DRESSING
FORCEPS
150mm



WI-SU-507
Mc INDOE DRESSING
TISSUE FORCEPS
150mm



WI-SU-516
DISSECTING TISSUE FORCEPS
1X2 TEETH CVD 14CM
(MEDIUM)



WI-SU-517
DISSECTING FORCEPS MEDIUM
CVD 14CM



WI-SU-518 150mm
GILLIES / DISSECTING
FORCEPS (STANDARD)



TOWEL CLUMP (JONES)
WI-SU-519 85MM
WI-SU-520 /1 95MM

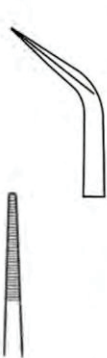

WI-SU-521
IRIS DISSECTING DELICATE
FORCEPS
STR 100 mm



WI-SU-522
STR

WI-SU-523
ANGLED
MICROSCOPY FORCEPS
VERY FINE 100 mm



WI-SU-524
IRIS DISSECTING DELICATE
FORCEPS
CVD 100 mm



WI-SU-525
DELICATE TISSUE FORCEPS
CVD 100 mm

WITH PIN
WI-SU-526 STR 100mm
WI-SU-527 STR 115mm
WI-SU-528 STR 130mm
WI-SU-529 STR 140mm



**DELICATE DISSECTING FORCEPS
WITH OUT PIN**
WI-SU-530 STR 100mm
WI-SU-531 STR 115mm
WI-SU-532 STR 130mm
WI-SU-533 STR 140mm

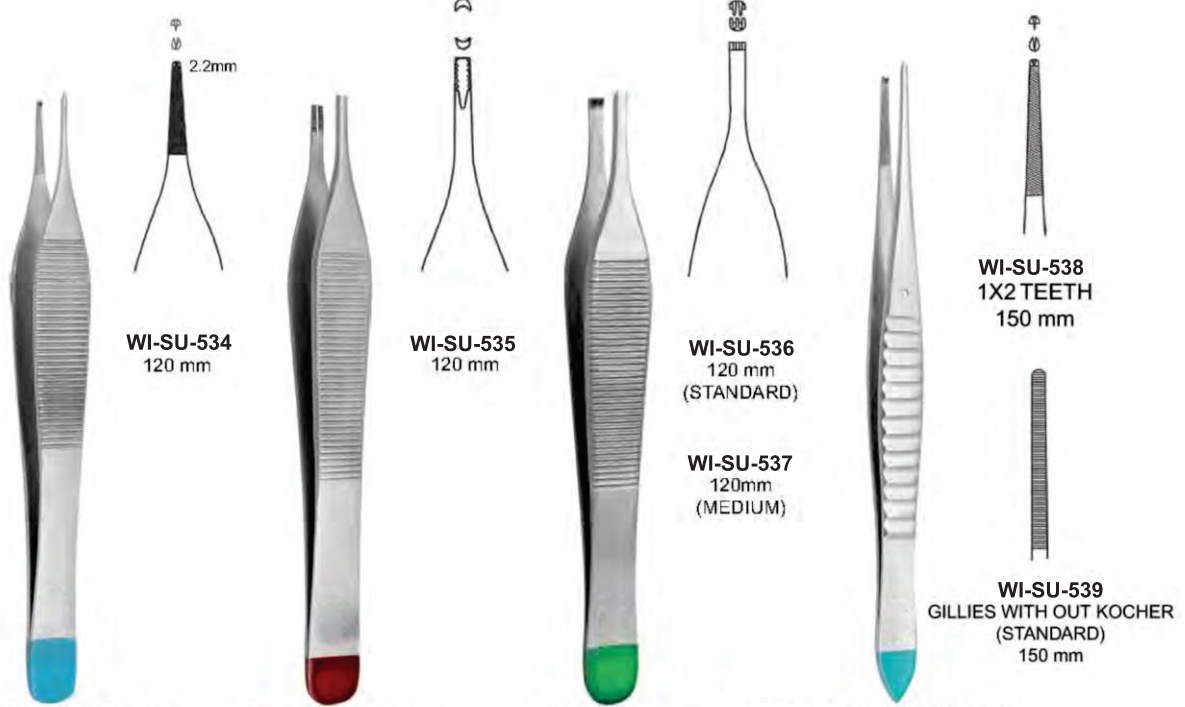

WI-SU-534
120 mm

WI-SU-535
120 mm

WI-SU-536
120 mm
(STANDARD)

WI-SU-537
120mm
(MEDIUM)

WI-SU-538
1X2 TEETH
150 mm

WI-SU-539
GILLIES WITH OUT KOCHER
(STANDARD)
150 mm

ADSON TISSUE FORCEPS
1X2 Teeth with Plateau

ADSON BROWN
Tissue Forceps ,Sharp

ADSON TISSUE
FORCEPS
2X3 Teeths

GILLIES TISSUE FORCEPS

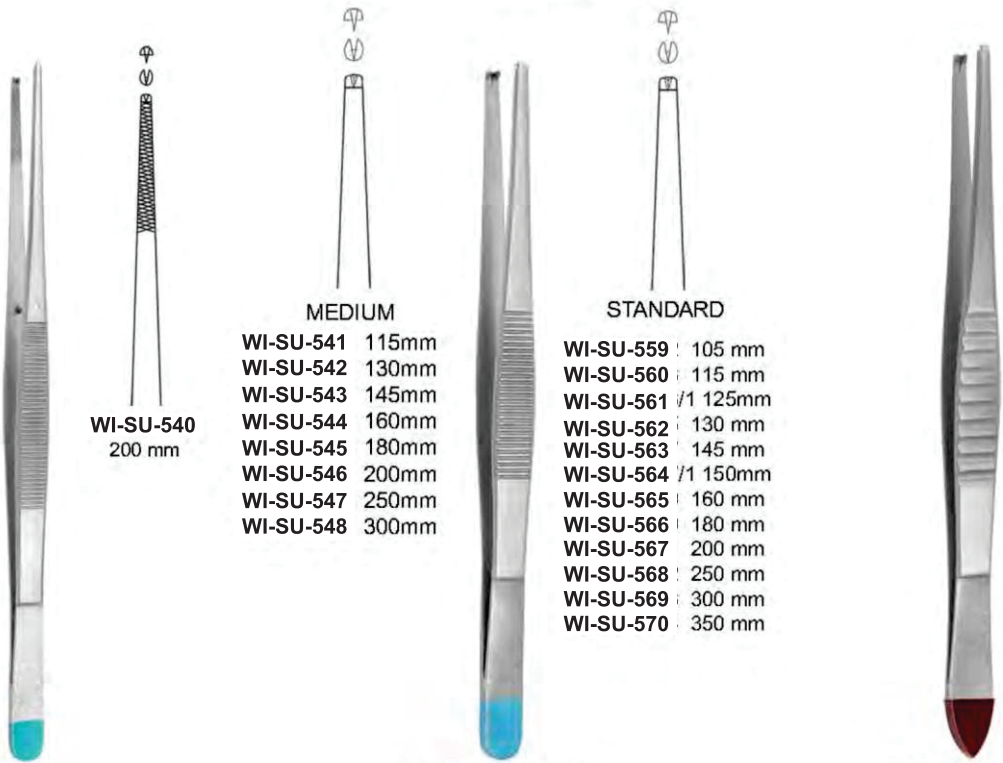

WI-SU-540
200 mm

MEDIUM

- WI-SU-541 : 115mm
- WI-SU-542 : 130mm
- WI-SU-543 : 145mm
- WI-SU-544 : 160mm
- WI-SU-545 : 180mm
- WI-SU-546 : 200mm
- WI-SU-547 : 250mm
- WI-SU-548 : 300mm

STANDARD

- WI-SU-559 : 105 mm
- WI-SU-560 : 115 mm
- WI-SU-561 : 125mm
- WI-SU-562 : 130 mm
- WI-SU-563 : 145 mm
- WI-SU-564 : 150mm
- WI-SU-565 : 160 mm
- WI-SU-566 : 180 mm
- WI-SU-567 : 200 mm
- WI-SU-568 : 250 mm
- WI-SU-569 : 300 mm
- WI-SU-570 : 350 mm

TISSUE FORCEPS
(WAUGH)
1X2 Teeth

TISSUE FORCEPS
1X2 Teeth

WI-SU-571 |
GILLIES TISSUE FORCEPS
STANDARD 1X2 TEETH
150 mm

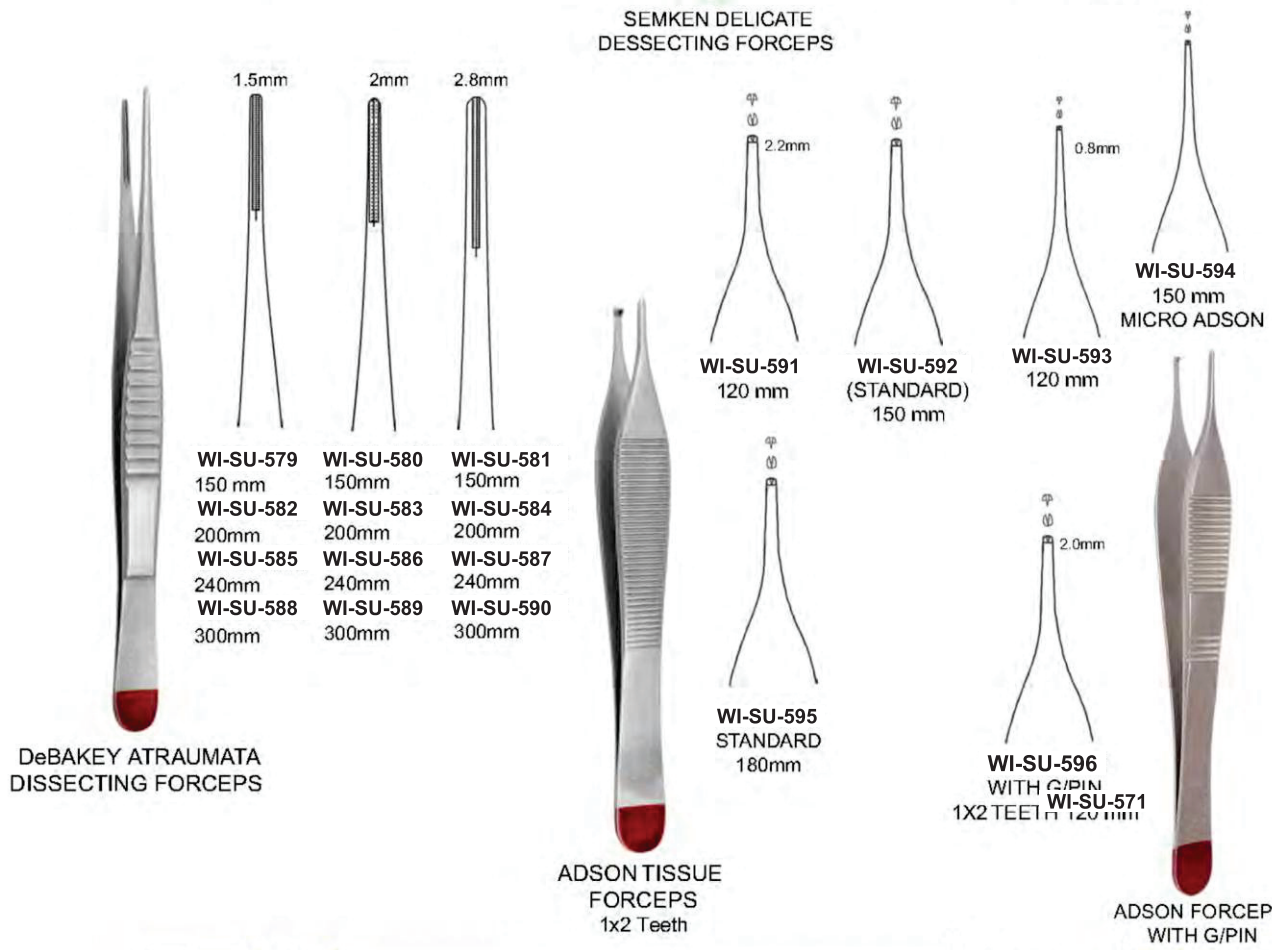
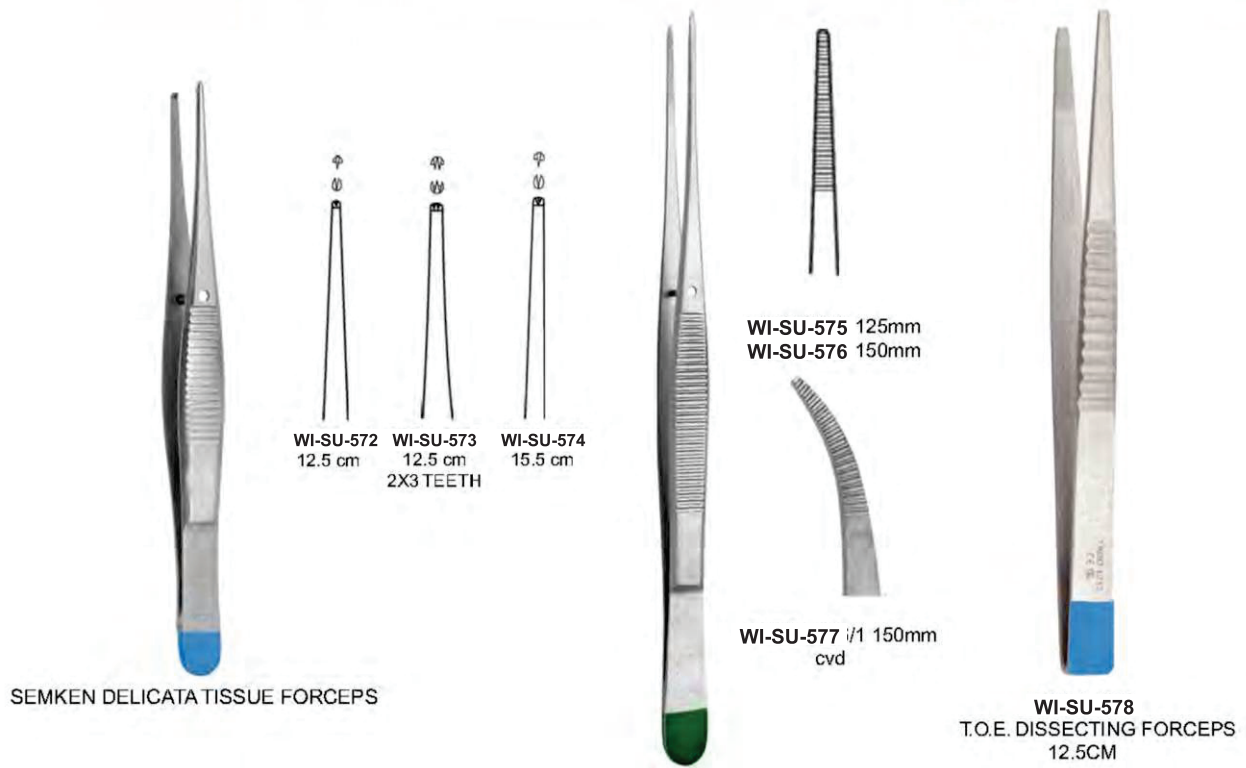



WI-SU-597 14CM
WI-SU-598 20CM
LUCAE TISSUE FORCEPS
BAYONET SHAPED
1X2 TEETH



WI-SU-599 14CM
WI-SU-600 20CM
JANSSEN (LUCAE) MICRO
GRASPING FORCEPS
BAYONET SHAPED



WI-SU-601
JANSSEN DISSECTING FORCEPS
BAYONET SHAPED
16CM



WI-SU-602
GRUWALD DISSECTING FORCEPS
BAYONET SHAPED
16CM



WI-SU-603
HUNTER SPLINTER FORCEPS
CVD 10.5CM



WI-SU-607
HUNTER SPLINTER
FORCEPS STR 10.5CM



WI-SU-608
MOORFIELD EYE FORCEPS
10CM



WI-SU-609
TISSUE FORCEPS VERY
DELICATE
1X2 TEETH 10CM STR



WI-SU-604
WI-SU-605
WILLIGER CURETTES
170 mm



WI-SU-606
210 mm
BONE CURETTES
DOUBLE ENDED



WITTEX
INTERNATIONAL

Manufacturers & Exporters of Single Use Instruments

RETRACTORS

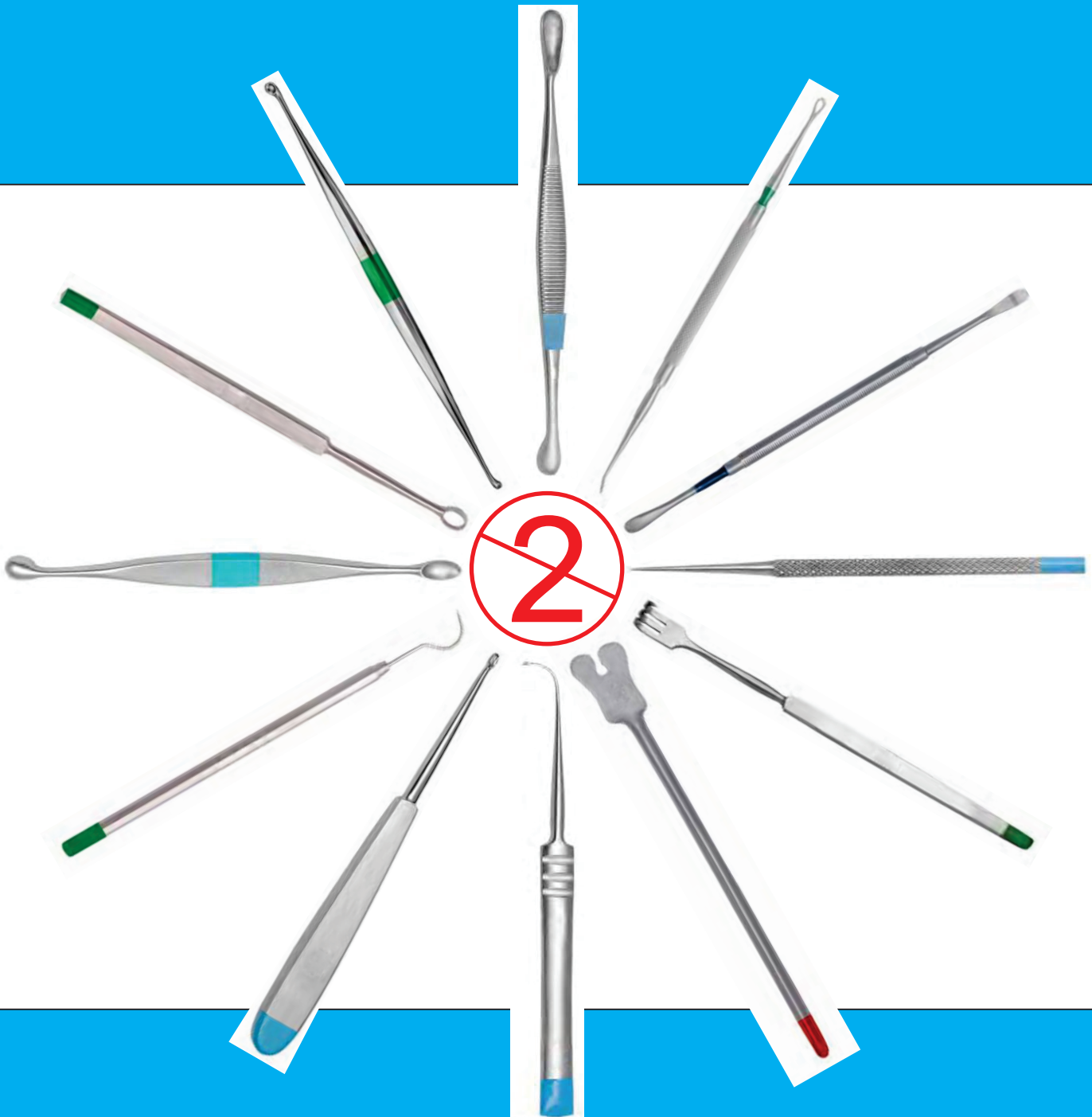

 www.wittex.com



WI-SU-610
DIEFFENBACH BULLDOG CLAMP ,
58MM STR, JAW LENGHT 16MM



WI-SU-611
DIEFFENBACH BULLDOG CLAMP ,
58MM CVD, JAW LENGHT 16MM



WI-SU-612
DIEFFENBACH BULLDOG CLAMP ,
38MM STR, JAW LENGHT 12MM



WI-SU-615
JANSEN BONE
CURETTE
DOUBLE ENDED
160 mm



WI-SU-613
De BEKEY ATRAUMATA BULLDOG CLAMP
105MM , STR, JAW LENGTH 50MM



WI-SU-614
De BEKEY ATRAUMATA BULLDOG CLAMP
97MM , CVD, JAW LENGTH 42MM



NASAL SPECULUM
THUDICHUM (MARK HOVELL)



WI-SU-616
8.5 X 6.0, 70MM



WI-SU-617
9.0 X 7.0, 71MM



WI-SU-618
12.5 X 8.0, 72MM



WI-SU-619
15.0 X 8.5, 73MM



WI-SU-620
16.5 X 9.0, 74MM



WI-SU-621
18.0 X 10.0, 74MM



WI-SU-622
19.5 X 10.5, 75MM



WI-SU-623 2.0 x 3.2mm
FREER SKIN RETRACTOR
PLAIN HANDLE
2 , SMALL PRONGS 15CM



WI-SU-624 3MM
WI-SU-625 6MM
WI-SU-626 8MM
WI-SU-627 10MM
FREER SKIN RETRACTOR
PLAIN HANDLE
2 ,LONG PRONGS 15CM



WI-SU-628
PROBE BUTTERFLY
14cm



WI-SU-629
PROBE BUTTERFLY
WITH TIP
14cm



WI-SU-630 17CM
WI-SU-631 30CM
FLAT HANDLE ROOT ELEVATOR
(BIEN) AROUND TIP



WI-SU-632 19X15MM
WI-SU-633 22X17MM
ADENOID CURETTE BECKMANN
20CM



TABT 1122/2GQ
RETRACTOR SLAMM CURVE,
2 PRONGS SHARP,
DEPTH 5MM,WIDTH 4.2MM
18CM



TAOL 8211-2GQ
FREER SKIN HOOK 2PRONGS, SHARP,
DEPTH 3.3MM,WIDTH 5.5MM
18CM

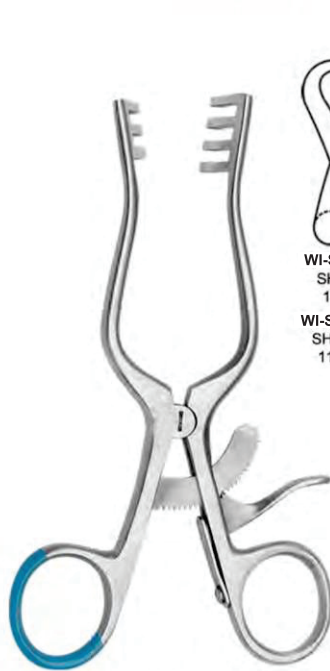

WEITLANER RETRACTORS



WI-SU-634
SHARP
13CM

WI-SU-635
SHARP
11CM



WI-SU-636
SEMI SHARP
13CM

WI-SU-637
SEMI SHARP
11CM



WI-SU-638
BLUNT
13CM

WI-SU-639
BLUNT
11CM



TABT 0099
JACKSON TRACHEAL RETRACTOR
DOUBLE ENDED 18CM



WI-SU-640
10x6 mm



WI-SU-641
15x6 mm



WI-SU-642
17x6 mm



WI-SU-643
20x6 mm



WI-SU-644
22x8 mm



WI-SU-645
25x6 mm



WI-SU-646
30x8 mm



LANGENBECK RETRACTOR SENN GREEN
PLAN HANDLE 16CM



WI-SU-647
10x6MM



WI-SU-648
15x6MM



WI-SU-649
17x6MM



WI-SU-650
20x6MM



WI-SU-651
22x8MM



WI-SU-652
25x8MM



WI-SU-653
30x8MM



LANGENBECK MANNERFELT
RETRACTOR FLAT HANDLE WITH PRINT
15 CM



WI-SU-654
10x6MM



WI-SU-655
15x6MM



WI-SU-656
17x6MM



WI-SU-657
20x6MM



WI-SU-658
22x8MM



WI-SU-659
25x8MM



WI-SU-660
30x8MM



LANGENBECK RETRACTOR
SENN GREEN WITH
PRINT HANDLE
16CM



I/DIA
 WI-SU-661 2MM 14CM
 WI-SU-662 3MM 14CM
 WI-SU-663 4MM 14CM
 WI-SU-664 5MM 14CM
 WI-SU-665 6MM 14CM

I/DIA
 WI-SU-666 /12MM 20CM
 WI-SU-667/1 3MM 20CM
 WI-SU-668/1 4MM 20CM
 WI-SU-669/1 5MM 20CM
 WI-SU-670/1 6MM 20CM



5X10mm
 WI-SU-671
 WITH OUT PRINT

13X5mm



8X7mm

22X7mm



6.8mm

5.5mm



8.6mm

6.6mm

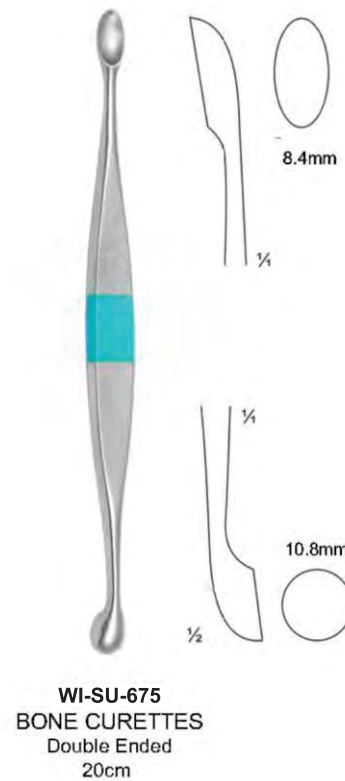

8.4mm

1/4

1/4

10.8mm

1/2



**DESMARRES LID
RETRACTORS**
14cm

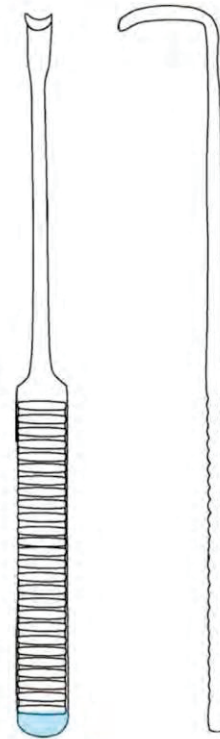

**WI-SU-682 /GQ
STRANDELL-STILLE**
Wound Retractor With Prong Blunt,
depth 20mm, width 6mm
18cm



**SENN-MILLER RETRACTORS
DOUBLE ENDED**
15.5CM



**WI-SU-683
SHARP**

**WI-SU-684 /1
SEMI SHARP**



**YASARGIL HOOK
PRINT HANDLE**
16.5cm



**WOUND RETRACTORS
PLAIN HANDLE**
16.5cm



WOUND RETRACTORS SMALL CURVED ,SHARP
5.0 X 4.2mm 5.0 x 7.0mm 5.0 x 9.5mm



WOUND RETRACTORS SMALL CURVED ,BLUNT
4.2 X 4.2mm 4.5 X 7.0mm 4.5 X 9.5mm

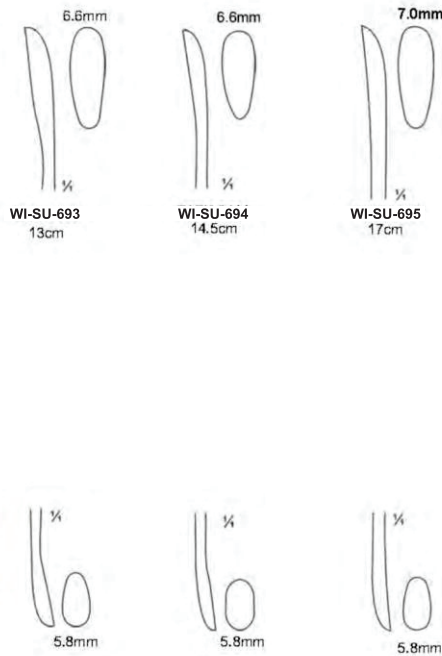

**VOLKMANN BONE CURETTES
DOUBLE ENDED**

WI-SU-702 /0 7MM
WI-SU-703 /1 6MM
WI-SU-704 /2 4MM
WI-SU-705 /3 2MM
WI-SU-706 /4 3MM

**BONE CURETTE
SINGLE ENDED, SHARP
PRINT HANDLE
14CM**



WI-SU-707 /0 7MM
WI-SU-708 /1 6MM
WI-SU-709 /2 4MM
WI-SU-710 /3 2MM
WI-SU-711 /4 3MM

**BONE CURETTE
SINGLE ENDED, SHARP
HANDLE WITH OUT PRINT
14CM**



**WI-SU-712
TW DILATATOR PROBE
10CM**



ROUND	SHARP
WI-SU-696 3.5 X 4.5 mm	WI-SU-699 3.6 X 4.5 mm
WI-SU-697 4.0 X 7.2 mm	WI-SU-700 4.0 X 7.5 mm
WI-SU-698 4.0 X 10.0 mm	WI-SU-701 4.0 X 10.2 mm

**WOUND RETRACTOR
FLEXIBLE SHAFT 16 CM**



**WI-SU-713
STRAUS PENIS CLAMP 130MM
OPENING 4.5CM GAGE WIRE #15**



WI-SU-714
WI-SU-715
PROBES & EXPLORER
23 ,15CM



WI-SU-716
WI-SU-717
PROBES & EXPLORER
23 ,15CM



WI-SU-718
NAIL FILE 15CM



TAKW 1766
KIRSCHNER WIRE, ANGLED
14.5CM



WI-SU-721 /R # 3
OESCH MULLER HOOK SMALL
TAOH 1833/3R SLIGHTLY CVD
RIGHT HAND



WI-SU-720
LEFT HAND
TAOH 1833/1L RU
R/USABLE



WI-SU-722 /R # 2
OESCH MULLER HOOK MEDIUM
TAOH 1822/3R SLIGHTLY CVD
RIGHT HAND



WI-SU-721
LEFT HAND
TAOH 1822/1L RU
R/USABLE



WI-SU-723 /R # 1
OESCH MULLER HOOK LARGE
TAOH 1811/3R SLIGHTLY CVD
RIGHT HAND



WI-SU-722
LEFT HAND
TAOH 1811/1L RU
R/USABLE



WI-SU-724
FORMBY CERUMEN SCOOP & HOOK
18CM



WI-SU-725
2.35 mm
SMALL

WI-SU-726
3.65 mm
MEDIUM

WI-SU-727
4.20 mm
LARGE

**GILLIES SKIN HOOK
RETRACTORS**
180 mm



WI-SU-728
FREER RASPATORY
ELEVATOR SHARP/ BLUNT
18CM



WI-SU-729
BABY SENN MILLER
8X7 22X7MM 10CM

- 2.0mm WI-SU-730
- 1.5mm WI-SU-731
- 1.0mm WI-SU-732
- 0.5mm WI-SU-733
- TAOF 2777 SMALL
- TAOF 2788 MEDIUM
- TAOF 2799 LARGE

WI-SU-729

- WI-SU-730** /#1 2.0mm
- WI-SU-731** /#1 1.5mm
- WI-SU-732** /#1 1.0mm
- WI-SU-733** /#1 0.5mm



**WAGENER EAR HOOK,
PROBE ENDED BALL**
90 DIGREE ANGLED, 15CM



**WAGENER EAR HOOK,
PROBE ENDED**
15CM



WI-SU-734
JANSEN ROUND HANDLE,
EAR CURETTE, DOUBLE ENDED
2.5mm , 3.4mm
18CM



WI-SU-735
JANSEN ROUND HANDLE,
EAR CURETTE, DOUBLE ENDED
1mm , 2mm
13CM



WI-SU-736 23 CM
LANE WOUND RETRACTORS



WI-SU-737 23 CM
LANE WOUND RETRACTORS



WI-SU-738 13.5CM
BABY-ROUX WOUND RETRACTORS

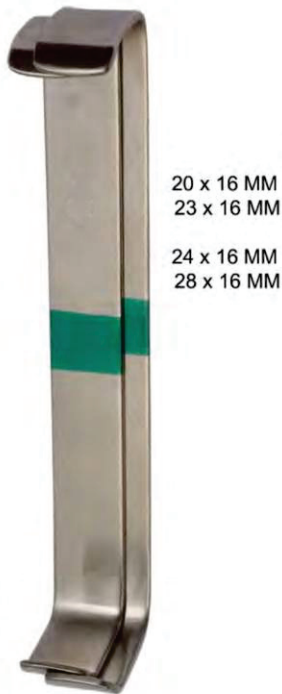

WI-SU-739 15CM
FARABEUW WOUND RETRACTOR
DOUBLE-ENDED, SET OF 2

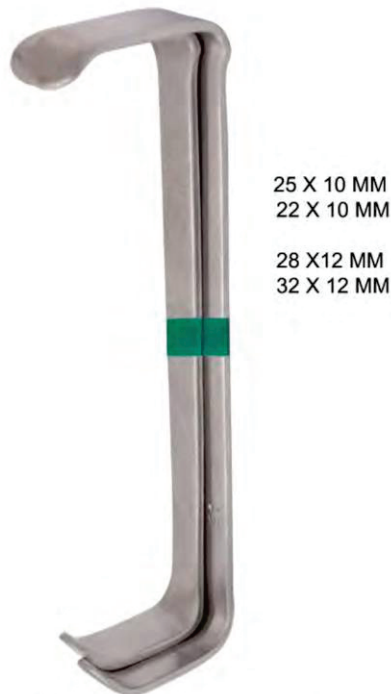

WI-SU-740 12CM
FARABEUW WOUND RETRACTOR
DOUBLE ENDED, SET OF 2



WI-SU-741
WI-SU-742
ROUX WOUND RETRACTOR



26 x 15 MM
22 x 15 MM
30 x 15 MM
43 x 15 MM

WI-SU-743
US ARMY RETRACTOR
SET OF 2, 22CM



16 X 33 MM
12 X 32 MM
16 X 29 MM
12 X 27 MM

WI-SU-744
LANE WOUND RETRACTOR
SET OF 2 16.5CM



38 X 22 MM

38 X 22 MM

WI-SU-745 17.5CM
CZERNY WOUND RETRACTORS



11x 4 MM

19 x 6 MM

WI-SU-746 11CM
CRILE WOUND RETRACTORS



WI-SU-747
10x6 mm



WI-SU-748
15x6 mm



WI-SU-749
17x6 mm



WI-SU-750
20x6 mm



WI-SU-751
22x8 mm



WI-SU-752
25x8 mm



WI-SU-753
30x8 mm



LANGENBECK MANNERFELT
RETRACTOR ROUND HANDLE
15 CM



WI-SU-754
10x6 mm



WI-SU-755
15x6 mm



WI-SU-756
17x6 mm



WI-SU-757
20x6 mm



WI-SU-758
22x8 mm



WI-SU-759
25x8 mm



WI-SU-760
30x8 mm



MINI LANGENBECK
RETRACTOR PLAN HANDLE 15 CM



36 X 44 MM
30 X 24 MM

36 X 44 MM
30 X 24 MM

WI-SU-761 18CM
PARKER WOUND RETRACTORS
SET OF 2



22 X 15 MM
18 X 15 MM

18 X 15 MM
22 X 15 MM

WI-SU-762 13.5CM
PARKER WOUND RETRACTORS
SET OF 2



21 X 14 MM
17 X 14 MM

28 X 16 MM
32 X 16 MM

WI-SU-763 15CM
COLLIN WOUND RETRACTORS
SET OF 2



19 X 22 MM
23 X 30 MM
WI-SU-764
25 X 26 MM
28 X 38 MM
WI-SU-765
28 X 29 MM
33 X 45 MM
WI-SU-766

ROUX WOUND RETRACTORS
SET OF 3 17CM



20 X 22 MM
25 X 29 MM
WI-SU-767
15 CM
25 X 26 MM
30 X 38 MM
WI-SU-768
16 CM
28 X 29 MM
33 X 44 MM
WI-SU-769
17 CM

ROUX WOUND RETRACTORS
SET OF 3



10 X 8MM

12 x 11MM

WI-SU-770
LUER WOUND RETRATOR
DOUBLE ENDED
11 CM



WI-SU-771
NORDBERG ROGINE CUTTING INSTRUMENTS 17CM



WI-SU-772
PERIODONTOMETER (WILLIAMS) 15CM 3 3 2 3MM PCP 11



WI-SU-773
PERIODONTOMETERS, PCP 11,3 HOLLOW SINGLE HANDLE 15CM



WI-SU-774 NORDBERG ROGINE 15CM



WI-SU-775
INSTRUMENT FOR LIFTING TEMPORARY STOPPING 16.5CM



WI-SU-776
PERIODONTAL PROBE 15CM



WI-SU-777
7 EXPLORER SONDE 14.5CM

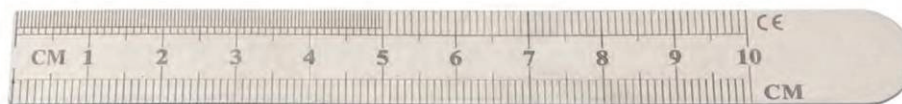

WI-SU-778
STEEL RULLER 10CM



WI-SU-779
STEEL RULLER 15CM



WITTEX
INTERNATIONAL

Manufacturers & Exporters of Single Use Instruments

SUCTION TUBES



 www.wittex.com

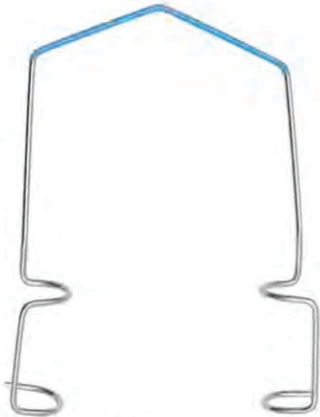

WI-SU-780
BARRAQUER EYE SPECULUM OPEN LOOP



WI-SU-781
KFRSHNER EYE SPECULUM



**EYE EPECULA
BARRAQUER**
WI-SU-782 3 CM
WI-SU-783 4 CM



WI-SU-784
BABY EYE SPECULUM



WI-SU-785 BLADE 15.5MM
ADULT EYE SPECULUM 50MM
WI-SU-786 BLADE 14MM
CHILD EYE SPECULUM 40MM



WI-SU-787
BARRAQUER
EYE SPECULUM CLOSED LOOP



SIMS UTERINE PROBE CURVED, GRADUATED, DIA 4 MM 33CM
WI-SU-788

SIMS UTERINE PROBE CURVED, MALLEABLE, DIA 4 MM 33CM
WI-SU-789



SIMS UTERINE PROBE MALLEABLE, CURVED, GRADUATED, DIA 3 MM 33CM
WI-SU-790



WI-SU-791
DESMOTOM STRAIGHT
FILIGREE 16CM



WI-SU-792
DESMOTOM LEFT
FILIGREE 17CM



WI-SU-793
DESMOTOM RIGHT
FILIGREE 17CM



WI-SU-794
VARADY PHLEBOEXTRACTOR
18CM



WI-SU-797
MIDDELDORPF
CHEEK RETRACTOR
15X15MM, 22CM



WI-SU-795
MIDDELDORPF
CHEEK RETRACTOR
20X22MM, 22CM



WI-SU-796
MIDDELDORPF
CHEEK RETRACTOR
28X28MM, 22CM



WI-SU-798
LUER LOCK CANNULA NEEDLE OD 3.2MM 80° ANGLED
70MM LENGTH

WI-SU-799
LUER LOCK CANNULA NEEDLE OD 4.2MM 80° ANGLED
75MM LENGTH
GENTOFTE VAGINAL SPECULUM 15X80MM, 32X100MM 21CM



CANNULA SUCTION NEEDLE STR

12cm

- WI-SU-800 1.9mm
- WI-SU-801 0 1.0mm
- WI-SU-802 1 1.2mm
- WI-SU-803 2 2.0mm
- WI-SU-804 3 2.2mm

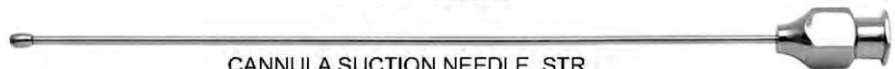

CANNULA SUCTION NEEDLE STR

10cm

- WI-SU-805 1.9mm
- WI-SU-806 0 1.0mm
- WI-SU-807 1 2.0mm
- WI-SU-808 2 2.2mm
- WI-SU-809 3 1.2mm
- WI-SU-810 4 1.6mm
- WI-SU-811 5 1.5mm

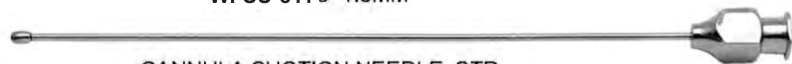

CANNULA SUCTION NEEDLE STR

8cm

- WI-SU-812 0.8mm
- WI-SU-813 1 1.2mm
- WI-SU-814 2 2.0mm
- WI-SU-815 3 1.0mm
- WI-SU-816 4 1.9mm
- WI-SU-817 5 2.2mm
- WI-SU-818 6 1.5mm



CANNULA SUCTION NEEDLE STR

6cm

- WI-SU-819 1.0mm
- WI-SU-820 1 1.2mm
- WI-SU-821 2 1.4mm
- WI-SU-822 3 1.9mm
- WI-SU-823 4 2.0mm



WI-SU-824

GEBOGEN LUER LOCK CANNULA NEEDLE OD 2MM LENGTH 73MM BANDED

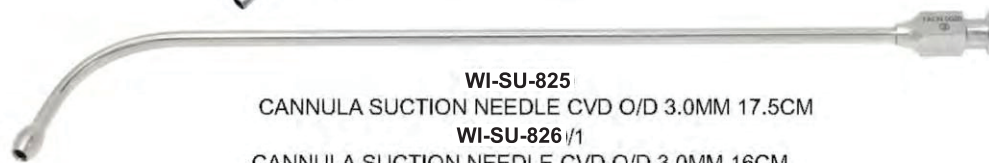

WI-SU-825

CANNULA SUCTION NEEDLE CVD O/D 3.0MM 17.5CM

WI-SU-826 /1

CANNULA SUCTION NEEDLE CVD O/D 3.0MM 16CM



WI-SU-827

WOLF INJECTION CANNULA NEEDLE WITH WIRE 35CM

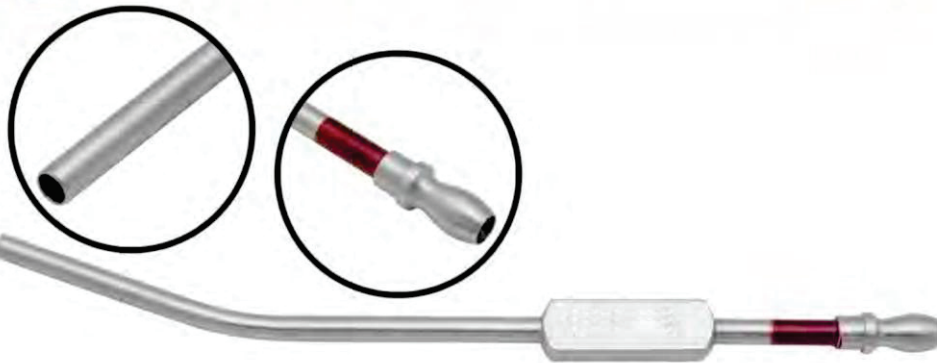

WI-SU-828

ORL SUCTION TUBE DIA 5.0MM WORKING LENGTH 10CM ANGLED UP 18 CM



WI-SU-829

ORL SUCTION TUBE DIA 3.0MM WORKING LENGTH 8CM ANGLED UP 14CM

- CH- 8 2.7MM **WI-SU-830**
- CH- 10 3.3MM **WI-SU-831**
- CH- 12 4.0MM **WI-SU-832**
- CH- 14 4.7MM **WI-SU-833**
- CH- 16 5.3MM **WI-SU-834**
- CH- 18 6.0MM **WI-SU-835**

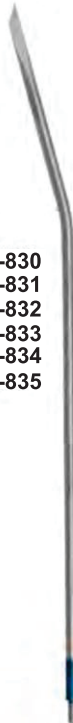

REDON GUIDE NEEDLE
WITH THREAD KNIFE TIP,
SLIGHTLY CURVED 190MM

- CH- 8 2.7MM **WI-SU-836**
- CH- 10 3.3MM **WI-SU-837**
- CH- 12 4.0MM **WI-SU-838**
- CH- 14 4.7MM **WI-SU-839**
- CH- 16 5.3MM **WI-SU-840**
- CH- 18 6.0MM **WI-SU-841**

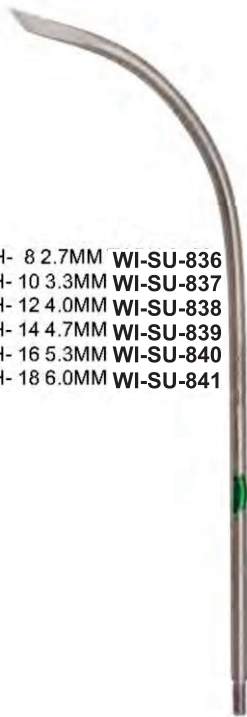

REDON GUIDE NEEDLE
WITH THREAD KNIFE TIP,
STROGLY CURVED 190MM

- CH- 8 2.7MM **WI-SU-842**
- CH- 10 3.3MM **WI-SU-843**
- CH- 12 4.0MM **WI-SU-844**
- CH- 14 4.7MM **WI-SU-845**
- CH- 16 5.3MM **WI-SU-846**
- CH- 18 6.0MM **WI-SU-847**



REDON GUIDE NEEDLE
WITH THREAD KNIFE TIP,
HIGHLY STROGLY CURVED 190MM



WI-SU-848
MAGILL SUCTION CANNULA



WI-SU-849
POOL SUCTION TUBE REGULAR HOLE
WORKING LENGTH 17CM
TOTAL LENGTH 22CM



WI-SU-850
POOL SUCTION TUBE SMALL HOLE
WORKING LENGTH 17CM
TOTAL LENGTH 22CM



WI-SU-851 14CM O/D 7MM
SUCTION CANNULA TUBE (TROCARS) (BLOW PIPE)
INNER DIA 1.5mm , 2.5mm , 3.0mm , 4.0mm , 6.0mm

WI-SU-852 /1 19CM O/D 7MM
SUCTION CANNULA TUBE (TROCARS) (BLOW PIPE)
INNER DIA 1.5mm , 2.5mm , 3.0mm , 4.0mm , 6.0mm



WI-SU-853
SUCTION BUTTON CANNULA
WORKING LENGTH 11.5CM
TOTAL LENGTH 15CM

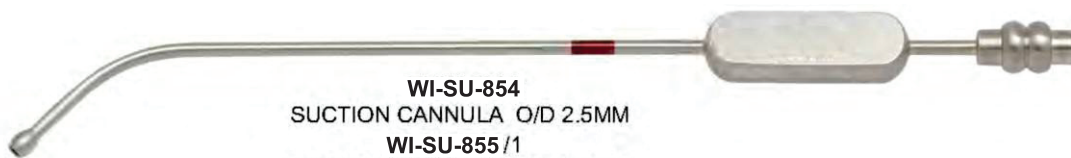

WI-SU-854
SUCTION CANNULA O/D 2.5MM

WI-SU-855 /1
SUCTION CANNULA O/D 3.0MM
WORKING LENGTH 11CM
TOTAL LENGTH 17.5CM



SUCTION NEEDLE ONE SIDE HOLE WITH LUER LOCK

- WI-SU-856 15MM O/D 1.2MM
- WI-SU-857 30MM O/D 1.2MM
- WI-SU-858 100MM O/D 1.2MM
- WI-SU-859 30MM O/D 2.0MM
- WI-SU-860 100MM O/D 2.0MM



SUCTION NEEDLE HOLE TO HOLE 1.2MM DISTANCE WITH LUER LOCK

- WI-SU-861 30MM O/D 1.2MM
- WI-SU-862 100MM O/D 1.2MM
- WI-SU-863 30MM O/D 2.0MM
- WI-SU-864 100MM O/D 2.0MM



TABN 4600 FARRELL COTTON APPLICATOR 1.2 MM DIAMETER, ROUND SERRATED END 14CM
 TABN 4600/1 FARRELL COTTON APPLICATOR 2.5 MM DIAMETER, ROUND SERRATED END 18CM



FREER SEPTUM CHISEL

- WI-SU-865 STR TIP SIZE 4MM 16CM
- WI-SU-866 CVD TIP SIZE 4 MM 16CM



WI-SU-867 NNER 1.0MM OUTER EDGE 2MM
 WI-SU-868 NNER 1.3MM OUTER EDGE 3MM
 BALLENGER SEPTUM GOUGE, WITH NOTCH AND CUTTING EDGE, I 17.5CM



JOBSON-HORNE ,EAR PROBE

- WI-SU-869 14CM
- WI-SU-870 18CM



WI-SU-871
 JAMISON SUCTION TUBE



WI-SU-872
PUNCTURE CANNULA NEEDLE 25CM 15G



WI-SU-873
PUNCTURE CANNULA NEEDLE 11G 12CM



WI-SU-874
PUNCTURE CANNULA NEEDLE 10G 12CM



WI-SU-875
SUCTION WITH FINE BOTTON TIP 115mm



WI-SU-876
SUCTION CANNULA NEEDLE 1.4mm 70mm 17G



WI-SU-877
SUCTION CANNULA NEEDLE ANGLED 60mm



WI-SU-878
SUBTENNON ANESTHESIA SUCTION CANNULA 20G



WI-SU-879
PUNCTURE CANNULA NEEDLE 14G W/L 11.5CM STR CUT DIA 2MM ,13CM



WI-SU-880

NOVAK CANNULA ENDOMETRIAL BIOPSY CURETTE WITH LUER LOCK WITH WIRE O/D 2MM 24cm

WI-SU-881

NOVAK CANNULA ENDOMETRIAL BIOPSY CURETTE WITH LUER LOCK WITH WIRE O/D 3MM 24cm

WI-SU-882

NOVAK CANNULA ENDOMETRIAL BIOPSY CURETTE WITH LUER LOCK WITH WIRE O/D 4MM 24cm



WI-SU-883

RANDALL CANNULA ENDOMETRIAL BIOPSY CURETTE O/D 2MM 24cm

WI-SU-884

RANDALL CANNULA ENDOMETRIAL BIOPSY CURETTE O/D 3MM 24cm

WI-SU-885

RANDALL CANNULA ENDOMETRIAL BIOPSY CURETTE O/D 4MM 24cm



WI-SU-886

SUCTION CANNULA WITH LUER LOCK WORKING LENGTH 7cm ROUND TIP



WI-SU-887

SUCTION CANNULA WITH LUER LOCK WORKING LENGTH 71MM V / SHAPE TIP



WI-SU-888

STAINLESS STEEL CLAMP 5.5cm



BOWMANN LACRIMAL SINUS PROBE

WI-SU-889 Dia 0.5 + 0.4MM Fig 0000/000

WI-SU-890 Dia 0.7 + 0.8MM Fig 00/0

WI-SU-891 Dia 0.9 + 1.1MM Fig 1/2

WI-SU-892 Dia 1.3 + 1.4MM Fig 3/4

WI-SU-893 Dia 1.5+ 1.6MM Fig 5/6

WI-SU-894 Dia 1.8+ 1.9MM Fig 7/8



WI-SU-895
PUNCTURE CANNULA NEEDLE 11G 30cm



WI-SU-896
PUNCTURE CANNULA NEEDLE 11G 25cm



WI-SU-897
SUCTION TUBE 90 DEGREE ANGLED OUTER DIA 0.4-2, 12.5 CM

WI-SU-898
SUCTION CANNULA NEEDLE W/L 30 O/D 1.2mm T/L 45mm WITH OLIVE BOTTON



WI-SU-899
SUCTION CANNULA NEEDLE 40mm



WI-SU-900
ZOLLNER SUCTION TUBE LUER LOCK OD 2.5MM 13cm

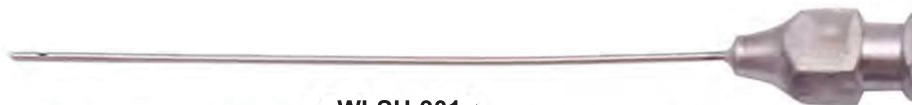

WI-SU-901
SUCTION CANNULE O-D 0.80 MM ROUND TIP WORKING LENGTH 60 MM

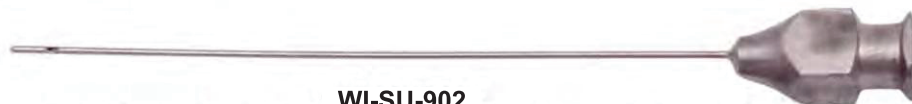

WI-SU-902
SUCTION CANNULE O-D 0.64 MM ROUND TIP WORKING LENGTH 60 MM

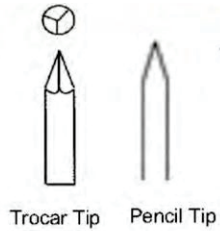

WI-SU-903
STRINMANN PIN, TROCAR TIP, 30CM O/D 2 mm, STR

WI-SU-904
KIRSCHNER WIRE O/D 2.0MM POUND POINTED TIP LIKE PENCIL LENGTH 30cm



WI-SU-905
CANNULA NEEDLE 2.7MM 9cm



WI-SU-906 3.1MM
KONISCH LUER LOCK 38mm
WI-SU-907 5.0MM
KONISCH LUER LOCK 38mm



WI-SU-908 47MM
NEEDLE INSIDE DIA 0.9MM OUTER DIA 1.55mm



WI-SU-909
CANNULA CONNECTOR 51.5mm LONG



WI-SU-910
CANNULA CONNECTOR 51.0mm LONG



WI-SU-911
CANNULA CONNECTOR 60.8mm LONG



WI-SU-912
CANNULA CONNECTOR 53.1mm LONG



WI-SU-913 ,45MM LONG
LUER LOCK CANNULA O/D 2.0MM, W/L 28mm



WI-SU-914 PUNCTURE CANNULA NEEDLE CVD 2.5mm
WI-SU-915 PUNCTURE CANNULA NEEDLE CVD 3.0mm



WI-SU-916
BAKALIT PROBE STAINLESS STEEL 60MM UPPER AREA 20cm



WI-SU-917
NIPPER PLIER DELICATE
12CM (WIRE CUTTER)



WI-SU-918
TONGUE DEPRESSOR
19CM



WI-SU-919
TOUNGE SEPRESSOR
L- SHAPE
15CM



WI-SU-920
RAGNELL RETRACTOR DOUBLE-ENDED
15CM



WI-SU-921
NAIL CUTTER 14CM



HARTMANN EAR SPECULA FOR ADULT
AURAL , INSIDE NON-REFLECTIVE,
OUTSIDE MATT FINISH

- WI-SU-922 O/D 1MM
- WI-SU-923 O/D 2MM
- WI-SU-924 O/D 3MM
- WI-SU-925 O/D 4MM
- WI-SU-926 /1 O/D 4.5MM
- WI-SU-927 O/D 5MM
- WI-SU-928 /1 O/D 5.5MM
- WI-SU-929 O/D 6MM
- WI-SU-930 O/D 7MM



HARTMANN EAR SPECULA FOR BABY
AURAL , INSIDE NON-REFLECTIVE,
OUTSIDE MATT FINISH

- WI-SU-931 O/D 1.8MM
- WI-SU-932 O/D 2MM
- WI-SU-933 O/D 3MM
- WI-SU-934 O/D 3.2MM
- WI-SU-935 O/D 4MM
- WI-SU-936 O/D 4.6MM



PROBE DOUBLE ENDED

DIA 1.0mm		DIA 1.5mm		DIA 2.0mm	
WI-SU-937	11.5CM	WI-SU-944	11.5CM	WI-SU-951	11.5CM
WI-SU-938	13CM	WI-SU-945	13CM	WI-SU-952	13CM
WI-SU-939	14.5CM	WI-SU-946	14.5CM	WI-SU-953	14.5CM
WI-SU-940	16CM	WI-SU-947	16CM	WI-SU-954	16CM
WI-SU-941	18CM	WI-SU-948	18CM	WI-SU-955	18CM
WI-SU-942	20CM	WI-SU-949	20CM	WI-SU-956	20CM
WI-SU-943	25CM	WI-SU-950	25CM	WI-SU-957	25CM



PROBE WITH EYE

DIA 1.0mm		DIA 1.5mm		DIA 2.0mm	
WI-SU-958	11.5CM	WI-SU-965	11.5CM	WI-SU-972	11.5CM
WI-SU-959	13CM	WI-SU-966	13CM	WI-SU-973	13CM
WI-SU-960	14.5CM	WI-SU-967	14.5CM	WI-SU-974	14.5CM
WI-SU-961	16CM	WI-SU-968	16CM	WI-SU-975	16CM
WI-SU-962	18CM	WI-SU-969	18CM	WI-SU-976	18CM
WI-SU-963	20CM	WI-SU-970	20CM	WI-SU-977	20CM
WI-SU-964	25CM	WI-SU-971	25CM	WI-SU-978	25CM



PROBE WITH ARROW POINT

DIA 1.0mm		DIA 1.5mm		DIA 2.0mm	
WI-SU-979	11.5CM	WI-SU-986	11.5CM	WI-SU-993	11.5CM
WI-SU-980	13CM	WI-SU-987	13CM	WI-SU-994	13CM
WI-SU-981	14.5CM	WI-SU-988	14.5CM	WI-SU-995	14.5CM
WI-SU-982	16CM	WI-SU-989	16CM	WI-SU-996	16CM
WI-SU-983	18CM	WI-SU-990	18CM	WI-SU-997	18CM
WI-SU-984	20CM	WI-SU-991	20CM	WI-SU-998	20CM
WI-SU-985	25CM	WI-SU-992	25CM	WI-SU-999	25CM



ONE SIDE PROBE

DIA 1.0mm		DIA 1.5mm		DIA 2.0mm	
WI-SU-1000	11.5CM	WI-SU-1007	11.5CM	WI-SU-1014	11.5CM
WI-SU-1001	13CM	WI-SU-1008	13CM	WI-SU-1015	13CM
WI-SU-1002	14.5CM	WI-SU-1009	14.5CM	WI-SU-1016	14.5CM
WI-SU-1003	16CM	WI-SU-1010	16CM	WI-SU-1017	16CM
WI-SU-1004	18CM	WI-SU-1011	18CM	WI-SU-1018	18CM
WI-SU-1005	20CM	WI-SU-1012	20CM	WI-SU-1019	20CM
WI-SU-1006	25CM	WI-SU-1013	25CM	WI-SU-1020	25CM



WI-SU-1021
WULLSTEIN SUCTION TUBE OD 1.MM 13CM



WI-SU-1022
WULLSTEIN SUCTION TUBE OD 2.0MM 15CM



WI-SU-1023
WULLSTEIN SUCTION TUBE OD 1.0MM 13CM



WI-SU-1024
RECAMIER Uterine Curette rigid sharp
cutting edge 5mm Fig 00 width 4500mm 30cm



WI-SU-1025
RECAMIER Uterine Curette rigid sharp
cutting edge 6mm Fig 0 width 7500 mm 30cm



WI-SU-1026
LEAF PROBE 2MM 13CM



WI-SU-1027
YANKAUR SUCTION TUBE FLAT PLASTIC HANDLE 26.5CM



WI-SU-1028
YANKAUR SUCTION TUBE ROUND PLASTIC HANDLE 33CM



WI-SU-1029
YANKAUR SUCTION TUBE WITH TEAR DROP SPECIAL DESIGN 37CM

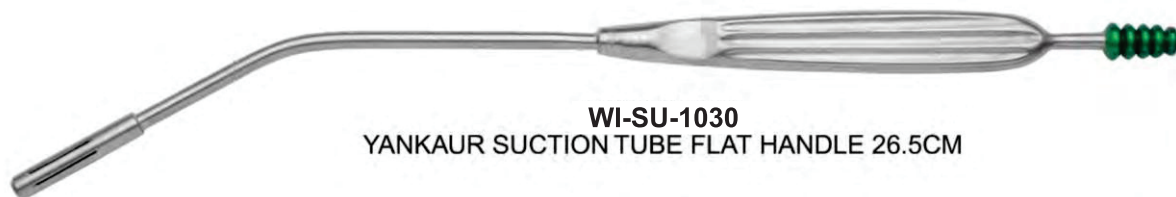

WI-SU-1030
YANKAUR SUCTION TUBE FLAT HANDLE 26.5CM



WI-SU-1031
YANKAUR SUCTION TUBE ROUND HANDLE 33CM



WI-SU-1032
SENNING SUCTION TUBE ROUND HANDLE 31CM



WI-SU-1033
YANKAUR SUCTION TUBE SAMI FLAT HANDLE 32.5CM



WI-SU-1034
YANKAUR SUCTION TUBE NEW VERSION FLAT HANDLE 33CM
(SPECIAL TUBE)

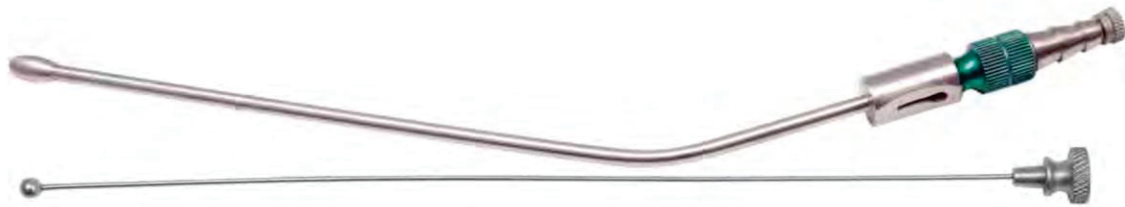

TEAR DROP FRAZIER SUCTION CANNULA TUBE WITH OLIVE & BALL WIRE

Sr. No.	Working Length Total Length Outer Diameter	S 110mm, 165mm,	M 125mm, 180mm,	L 150mm, 205mm,	LL 175mm, 230mm,	XXL 205mm, 260mm,
1	8 FR ○ 2.7MM	WI-SU-1035	WI-SU-1046	WI-SU-1057	WI-SU-1068	WI-SU-1079
2	9 FR ○ 3.0MM	WI-SU-1036	WI-SU-1047	WI-SU-1058	WI-SU-1069	WI-SU-1080
3	10 FR ○ 3.3MM	WI-SU-1037	WI-SU-1048	WI-SU-1059	WI-SU-1070	WI-SU-1081
4	12 FR ○ 4.0MM	WI-SU-1038	WI-SU-1049	WI-SU-1060	WI-SU-1071	WI-SU-1082
5	13 FR ○ 4.3MM	WI-SU-1039	WI-SU-1050	WI-SU-1061	WI-SU-1072	WI-SU-1083
6	14 FR ○ 4.7MM	WI-SU-1040	WI-SU-1051	WI-SU-1062	WI-SU-1073	WI-SU-1084
7	15 FR ○ 5.0MM	WI-SU-1041	WI-SU-1052	WI-SU-1063	WI-SU-1074	WI-SU-1085
8	16 FR ○ 5.3MM	WI-SU-1042	WI-SU-1053	WI-SU-1064	WI-SU-1075	WI-SU-1086
9	17 FR ○ 5.7MM	WI-SU-1043	WI-SU-1054	WI-SU-1065	WI-SU-1076	WI-SU-1087
10	18 FR ○ 6.0MM	WI-SU-1044	WI-SU-1055	WI-SU-1066	WI-SU-1077	WI-SU-1088
11	19 FR ○ 6.3MM	WI-SU-1045	WI-SU-1056	WI-SU-1067	WI-SU-1078	WI-SU-1089



TEAR DROP FRAZIER SUCTION CANNULA TUBE WITH OLIVE & MANDRAIN WIRE

Sr. No.	Working Length Total Length Outer Diameter	S 110mm, 165mm,	M 125mm, 180mm,	L 150mm, 205mm,	LL 175mm, 230mm,	XXL 205mm, 260mm,
1	3 FR ◦ 1.0MM	WI-SU-1090	WI-SU-1106	WI-SU-1122	WI-SU-1138	WI-SU-1154
2	4 FR ◦ 1.4MM	WI-SU-1091	WI-SU-1107	WI-SU-1123	WI-SU-1139	WI-SU-1155
3	5 FR ◦ 1.7MM	WI-SU-1092	WI-SU-1108	WI-SU-1124	WI-SU-1140	WI-SU-1156
4	6 FR ◦ 2.0MM	WI-SU-1093	WI-SU-1109	WI-SU-1125	WI-SU-1141	WI-SU-1157
5	7 FR ◦ 2.3MM	WI-SU-1094	WI-SU-1110	WI-SU-1126	WI-SU-1142	WI-SU-1158
6	8 FR ◦ 2.7MM	WI-SU-1095	WI-SU-1111	WI-SU-1127	WI-SU-1143	WI-SU-1159
7	9 FR ◦ 3.0MM	WI-SU-1096	WI-SU-1112	WI-SU-1128	WI-SU-1144	WI-SU-1160
8	10 FR ◦ 3.3MM	WI-SU-1097	WI-SU-1113	WI-SU-1129	WI-SU-1145	WI-SU-1161
9	12 FR ◦ 4.0MM	WI-SU-1098	WI-SU-1114	WI-SU-1130	WI-SU-1146	WI-SU-1162
10	13 FR ◦ 4.3MM	WI-SU-1099	WI-SU-1115	WI-SU-1131	WI-SU-1147	WI-SU-1163
11	14 FR ◦ 4.7MM	WI-SU-1100	WI-SU-1116	WI-SU-1132	WI-SU-1148	WI-SU-1164
12	15 FR ◦ 5.0MM	WI-SU-1101	WI-SU-1117	WI-SU-1133	WI-SU-1149	WI-SU-1165
13	16 FR ◦ 5.3MM	WI-SU-1102	WI-SU-1118	WI-SU-1134	WI-SU-1150	WI-SU-1166
14	17 FR ◦ 5.7MM	WI-SU-1103	WI-SU-1119	WI-SU-1135	WI-SU-1151	WI-SU-1167
15	18 FR ◦ 6.0MM	WI-SU-1104	WI-SU-1120	WI-SU-1136	WI-SU-1152	WI-SU-1168
16	19 FR ◦ 6.3MM	WI-SU-1105	WI-SU-1121	WI-SU-1137	WI-SU-1153	WI-SU-1169



TEAR DROP FRAZIER SUCTION CANNULA TUBE WITH BALL WIRE

Sr. No.	Working Length Total Length Outer Diameter	S 110mm, 165mm,	M 125mm, 180mm,	L 150mm, 205mm,	LL 175mm, 230mm,	XXL 205mm, 260mm,
1	8 FR ○ 2.7MM	WI-SU-1170	WI-SU-1181	WI-SU-1192	WI-SU-1203	WI-SU-1214
2	9 FR ○ 3.0MM	WI-SU-1171	WI-SU-1182	WI-SU-1193	WI-SU-1204	WI-SU-1215
3	10 FR ○ 3.3MM	WI-SU-1172	WI-SU-1183	WI-SU-1194	WI-SU-1205	WI-SU-1216
4	12 FR ○ 4.0MM	WI-SU-1173	WI-SU-1184	WI-SU-1195	WI-SU-1206	WI-SU-1217
5	13 FR ○ 4.3MM	WI-SU-1174	WI-SU-1185	WI-SU-1196	WI-SU-1207	WI-SU-1218
6	14 FR ○ 4.7MM	WI-SU-1175	WI-SU-1186	WI-SU-1197	WI-SU-1208	WI-SU-1219
7	15 FR ○ 5.0MM	WI-SU-1176	WI-SU-1187	WI-SU-1198	WI-SU-1209	WI-SU-1220
8	16 FR ○ 5.3MM	WI-SU-1177	WI-SU-1188	WI-SU-1199	WI-SU-1210	WI-SU-1221
9	17 FR ○ 5.7MM	WI-SU-1178	WI-SU-1189	WI-SU-1200	WI-SU-1211	WI-SU-1222
10	18 FR ○ 6.0MM	WI-SU-1179	WI-SU-1190	WI-SU-1201	WI-SU-1212	WI-SU-1223
11	19 FR ○ 6.3MM	WI-SU-1180	WI-SU-1191	WI-SU-1202	WI-SU-1213	WI-SU-1224



TEAR DROP FRAZIER SUCTION CANNULA TUBE WITH MANDRAIN WIRE

Sr. No.	Working Length Total Length Outer Diameter	S 110mm, 165mm,	M 125mm, 180mm,	L 150mm, 205mm,	LL 175mm, 230mm,	XXL 205mm, 260mm,
1	3 FR ◦ 1.0MM	WI-SU-1225	WI-SU-1241	WI-SU-1257	WI-SU-1273	WI-SU-1289
2	4 FR ◦ 1.4MM	WI-SU-1226	WI-SU-1242	WI-SU-1258	WI-SU-1274	WI-SU-1290
3	5 FR ◦ 1.7MM	WI-SU-1227	WI-SU-1243	WI-SU-1259	WI-SU-1275	WI-SU-1291
4	6 FR ◦ 2.0MM	WI-SU-1228	WI-SU-1244	WI-SU-1260	WI-SU-1276	WI-SU-1292
5	7 FR ◦ 2.3MM	WI-SU-1229	WI-SU-1245	WI-SU-1261	WI-SU-1277	WI-SU-1293
6	8 FR ◦ 2.7MM	WI-SU-1230	WI-SU-1246	WI-SU-1262	WI-SU-1278	WI-SU-1294
7	9 FR ◦ 3.0MM	WI-SU-1231	WI-SU-1247	WI-SU-1263	WI-SU-1279	WI-SU-1295
8	10 FR ◦ 3.3MM	WI-SU-1232	WI-SU-1248	WI-SU-1264	WI-SU-1280	WI-SU-1296
9	12 FR ◦ 4.0MM	WI-SU-1233	WI-SU-1249	WI-SU-1265	WI-SU-1281	WI-SU-1297
10	13 FR ◦ 4.3MM	WI-SU-1234	WI-SU-1250	WI-SU-1266	WI-SU-1282	WI-SU-1298
11	14 FR ◦ 4.7MM	WI-SU-1235	WI-SU-1251	WI-SU-1267	WI-SU-1283	WI-SU-1299
12	15 FR ◦ 5.0MM	WI-SU-1236	WI-SU-1252	WI-SU-1268	WI-SU-1284	WI-SU-1300
13	16 FR ◦ 5.3MM	WI-SU-1237	WI-SU-1253	WI-SU-1269	WI-SU-1285	WI-SU-1301
14	17 FR ◦ 5.7MM	WI-SU-1238	WI-SU-1254	WI-SU-1270	WI-SU-1286	WI-SU-1302
15	18 FR ◦ 6.0MM	WI-SU-1239	WI-SU-1255	WI-SU-1271	WI-SU-1287	WI-SU-1303
16	19 FR ◦ 6.3MM	WI-SU-1240	WI-SU-1256	WI-SU-1272	WI-SU-1288	WI-SU-1304



FRAZIER SUCTION CANNULA TUBE WITH MANDRAIN WIRE

Sr. No.	Working Lenght Total Lenght Outer Diameter	S 110mm, 165mm,	M 125mm, 180mm,	L 150mm, 205mm,	LL 175mm, 230mm,	XXL 205mm, 260mm,
1	3 FR ◦ 1.0MM	WI-SU-1305	WI-SU-1321	WI-SU-1337	WI-SU-1353	WI-SU-1369
2	4 FR ◦ 1.4MM	WI-SU-1306	WI-SU-1322	WI-SU-1338	WI-SU-1354	WI-SU-1370
3	5 FR ◦ 1.7MM	WI-SU-1307	WI-SU-1323	WI-SU-1339	WI-SU-1355	WI-SU-1371
4	6 FR ◦ 2.0MM	WI-SU-1308	WI-SU-1324	WI-SU-1340	WI-SU-1356	WI-SU-1372
5	7 FR ◦ 2.3MM	WI-SU-1309	WI-SU-1325	WI-SU-1341	WI-SU-1357	WI-SU-1373
6	8 FR ◦ 2.7MM	WI-SU-1310	WI-SU-1326	WI-SU-1342	WI-SU-1358	WI-SU-1374
7	9 FR ◦ 3.0MM	WI-SU-1311	WI-SU-1327	WI-SU-1343	WI-SU-1359	WI-SU-1375
8	10 FR ◦ 3.3MM	WI-SU-1312	WI-SU-1328	WI-SU-1344	WI-SU-1360	WI-SU-1376
9	12 FR ◦ 4.0MM	WI-SU-1313	WI-SU-1329	WI-SU-1345	WI-SU-1361	WI-SU-1377
10	13 FR ◦ 4.3MM	WI-SU-1314	WI-SU-1330	WI-SU-1346	WI-SU-1362	WI-SU-1378
11	14 FR ◦ 4.7MM	WI-SU-1315	WI-SU-1331	WI-SU-1347	WI-SU-1363	WI-SU-1379
12	15 FR ◦ 5.0MM	WI-SU-1316	WI-SU-1332	WI-SU-1348	WI-SU-1364	WI-SU-1380
13	16 FR ◦ 5.3MM	WI-SU-1317	WI-SU-1333	WI-SU-1349	WI-SU-1365	WI-SU-1381
14	17 FR ◦ 5.7MM	WI-SU-1318	WI-SU-1334	WI-SU-1350	WI-SU-1366	WI-SU-1382
15	18 FR ◦ 6.0MM	WI-SU-1319	WI-SU-1335	WI-SU-1351	WI-SU-1367	WI-SU-1383
16	19 FR ◦ 6.3MM	WI-SU-1320	WI-SU-1336	WI-SU-1352	WI-SU-1368	WI-SU-1384



FRAZIER SUCTION CANNULA TUBE WITH ANDRAIN BALL WIRE

Sr. No.	Working Length Total Length Outer Diameter	S 110mm, 165mm,	M 125mm, 180mm,	L 150mm, 205mm,	LL 175mm, 230mm,	XXL 205mm, 260mm,
1	8 FR ○ 2.7MM	WI-SU-1385	WI-SU-1396	WI-SU-1407	WI-SU-1418	WI-SU-1429
2	9 FR ○ 3.0MM	WI-SU-1386	WI-SU-1397	WI-SU-1408	WI-SU-1419	WI-SU-1430
3	10 FR ○ 3.3MM	WI-SU-1387	WI-SU-1398	WI-SU-1409	WI-SU-1420	WI-SU-1431
4	12 FR ○ 4.0MM	WI-SU-1388	WI-SU-1399	WI-SU-1410	WI-SU-1421	WI-SU-1432
5	13 FR ○ 4.3MM	WI-SU-1389	WI-SU-1400	WI-SU-1411	WI-SU-1422	WI-SU-1433
6	14 FR ○ 4.7MM	WI-SU-1390	WI-SU-1401	WI-SU-1412	WI-SU-1423	WI-SU-1434
7	15 FR ○ 5.0MM	WI-SU-1391	WI-SU-1402	WI-SU-1413	WI-SU-1424	WI-SU-1435
8	16 FR ○ 5.3MM	WI-SU-1392	WI-SU-1403	WI-SU-1414	WI-SU-1425	WI-SU-1436
9	17 FR ○ 5.7MM	WI-SU-1393	WI-SU-1404	WI-SU-1415	WI-SU-1426	WI-SU-1437
10	18 FR ○ 6.0MM	WI-SU-1394	WI-SU-1405	WI-SU-1416	WI-SU-1427	WI-SU-1438
11	19 FR ○ 6.3MM	WI-SU-1395	WI-SU-1406	WI-SU-1417	WI-SU-1428	WI-SU-1439



FRAZIER SUCTION CANNULA TUBE WITH OLIVE & BALL WIRE

Sr. No.	Working Length Total Length Outer Diameter	S 110mm, 165mm,	M 125mm, 180mm,	L 150mm, 205mm,	LL 175mm, 230mm,	XXL 205mm, 260mm,
1	8 FR ○ 2.7MM	WI-SU-1440	WI-SU-1451	WI-SU-1462	WI-SU-1473	WI-SU-1484
2	9 FR ○ 3.0MM	WI-SU-1441	WI-SU-1452	WI-SU-1463	WI-SU-1474	WI-SU-1485
3	10 FR ○ 3.3MM	WI-SU-1442	WI-SU-1453	WI-SU-1464	WI-SU-1475	WI-SU-1486
4	12 FR ○ 4.0MM	WI-SU-1443	WI-SU-1454	WI-SU-1465	WI-SU-1476	WI-SU-1487
5	13 FR ○ 4.3MM	WI-SU-1444	WI-SU-1455	WI-SU-1466	WI-SU-1477	WI-SU-1488
6	14 FR ○ 4.7MM	WI-SU-1445	WI-SU-1456	WI-SU-1467	WI-SU-1478	WI-SU-1489
7	15 FR ○ 5.0MM	WI-SU-1446	WI-SU-1457	WI-SU-1468	WI-SU-1479	WI-SU-1490
8	16 FR ○ 5.3MM	WI-SU-1447	WI-SU-1458	WI-SU-1469	WI-SU-1480	WI-SU-1491
9	17 FR ○ 5.7MM	WI-SU-1448	WI-SU-1459	WI-SU-1470	WI-SU-1481	WI-SU-1492
10	18 FR ○ 6.0MM	WI-SU-1449	WI-SU-1460	WI-SU-1471	WI-SU-1482	WI-SU-1493
11	19 FR ○ 6.3MM	WI-SU-1450	WI-SU-1461	WI-SU-1472	WI-SU-1483	WI-SU-1494



FRAZIER SUCTION CANNULA TUBE WITH OLIVE & MANDRAIN WIRE

Sr. No.	Working Length Total Length Outer Diameter	S 110mm, 165mm,	M 125mm, 180mm,	L 150mm, 205mm,	LL 175mm, 230mm,	XXL 205mm, 260mm,
1	3 FR ◦ 1.0MM	WI-SU-1495	WI-SU-1411	WI-SU-1427	WI-SU-1443	WI-SU-1459
2	4 FR ◦ 1.4MM	WI-SU-1496	WI-SU-1412	WI-SU-1428	WI-SU-1444	WI-SU-1460
3	5 FR ◦ 1.7MM	WI-SU-1497	WI-SU-1413	WI-SU-1429	WI-SU-1445	WI-SU-1461
4	6 FR ◦ 2.0MM	WI-SU-1498	WI-SU-1414	WI-SU-1430	WI-SU-1446	WI-SU-1462
5	7 FR ◦ 2.3MM	WI-SU-1499	WI-SU-1415	WI-SU-1431	WI-SU-1447	WI-SU-1463
6	8 FR ◦ 2.7MM	WI-SU-1500	WI-SU-1516	WI-SU-1532	WI-SU-1548	WI-SU-1564
7	9 FR ◦ 3.0MM	WI-SU-1501	WI-SU-1517	WI-SU-1533	WI-SU-1549	WI-SU-1565
8	10 FR ◦ 3.3MM	WI-SU-1502	WI-SU-1518	WI-SU-1534	WI-SU-1550	WI-SU-1566
9	12 FR ◦ 4.0MM	WI-SU-1503	WI-SU-1519	WI-SU-1535	WI-SU-1551	WI-SU-1567
10	13 FR ◦ 4.3MM	WI-SU-1504	WI-SU-1520	WI-SU-1536	WI-SU-1552	WI-SU-1568
11	14 FR ◦ 4.7MM	WI-SU-1505	WI-SU-1521	WI-SU-1537	WI-SU-1553	WI-SU-1569
12	15 FR ◦ 5.0MM	WI-SU-1506	WI-SU-1522	WI-SU-1538	WI-SU-1554	WI-SU-1570
13	16 FR ◦ 5.3MM	WI-SU-1507	WI-SU-1523	WI-SU-1539	WI-SU-1555	WI-SU-1571
14	17 FR ◦ 5.7MM	WI-SU-1508	WI-SU-1524	WI-SU-1540	WI-SU-1556	WI-SU-1572
15	18 FR ◦ 6.0MM	WI-SU-1509	WI-SU-1525	WI-SU-1541	WI-SU-1557	WI-SU-1573
16	19 FR ◦ 6.3MM	WI-SU-1510	WI-SU-1526	WI-SU-1542	WI-SU-1558	WI-SU-1574



FERGUSSON SUCTION CANNULA TUBE WITH BALL WIRE

Sr. No.	Working Length Total Length Outer Diameter	S 100mm, 165mm,	M 115mm, 180mm,	L 140mm, 205mm,	LL 165mm, 230mm,	XXL 195mm, 260mm,
1	8 FR ○ 2.7MM	WI-SU-1575	WI-SU-1586	WI-SU-1597	WI-SU-1608	WI-SU-1619
2	9 FR ○ 3.0MM	WI-SU-1576	WI-SU-1587	WI-SU-1598	WI-SU-1609	WI-SU-1620
3	10 FR ○ 3.3MM	WI-SU-1577	WI-SU-1588	WI-SU-1599	WI-SU-1610	WI-SU-1621
4	12 FR ○ 4.0MM	WI-SU-1578	WI-SU-1589	WI-SU-1600	WI-SU-1611	WI-SU-1622
5	13 FR ○ 4.3MM	WI-SU-1579	WI-SU-1590	WI-SU-1601	WI-SU-1612	WI-SU-1623
6	14 FR ○ 4.7MM	WI-SU-1580	WI-SU-1591	WI-SU-1602	WI-SU-1613	WI-SU-1624
7	15 FR ○ 5.0MM	WI-SU-1581	WI-SU-1592	WI-SU-1603	WI-SU-1614	WI-SU-1625
8	16 FR ○ 5.3MM	WI-SU-1582	WI-SU-1593	WI-SU-1604	WI-SU-1615	WI-SU-1626
9	17 FR ○ 5.7MM	WI-SU-1583	WI-SU-1594	WI-SU-1605	WI-SU-1616	WI-SU-1627
10	18 FR ○ 6.0MM	WI-SU-1584	WI-SU-1595	WI-SU-1606	WI-SU-1617	WI-SU-1628
11	19 FR ○ 6.3MM	WI-SU-1585	WI-SU-1596	WI-SU-1607	WI-SU-1618	WI-SU-1629



FERGUSSON SUCTION CANNULA TUBE WITH MANDRAIN WIRE

Sr. No.	Working Length Total Length Outer Diameter	S 100mm, 165mm,	M 115mm, 180mm,	L 140mm, 205mm,	LL 165mm, 230mm,	XXL 195mm, 260mm,
1	3 FR ◦ 1.0MM	WI-SU-1630	WI-SU-1646	WI-SU-1662	WI-SU-1678	WI-SU-1694
2	4 FR ◦ 1.4MM	WI-SU-1631	WI-SU-1647	WI-SU-1663	WI-SU-1679	WI-SU-1695
3	5 FR ◦ 1.7MM	WI-SU-1632	WI-SU-1648	WI-SU-1664	WI-SU-1680	WI-SU-1696
4	6 FR ◦ 2.0MM	WI-SU-1633	WI-SU-1649	WI-SU-1665	WI-SU-1681	WI-SU-1697
5	7 FR ◦ 2.3MM	WI-SU-1634	WI-SU-1650	WI-SU-1666	WI-SU-1682	WI-SU-1698
6	8 FR ◦ 2.7MM	WI-SU-1635	WI-SU-1651	WI-SU-1667	WI-SU-1683	WI-SU-1699
7	9 FR ◦ 3.0MM	WI-SU-1636	WI-SU-1652	WI-SU-1668	WI-SU-1684	WI-SU-1700
8	10 FR ◦ 3.3MM	WI-SU-1637	WI-SU-1653	WI-SU-1669	WI-SU-1685	WI-SU-1701
9	12 FR ◦ 4.0MM	WI-SU-1638	WI-SU-1654	WI-SU-1670	WI-SU-1686	WI-SU-1702
10	13 FR ◦ 4.3MM	WI-SU-1639	WI-SU-1655	WI-SU-1671	WI-SU-1687	WI-SU-1703
11	14 FR ◦ 4.7MM	WI-SU-1640	WI-SU-1656	WI-SU-1672	WI-SU-1688	WI-SU-1704
12	15 FR ◦ 5.0MM	WI-SU-1641	WI-SU-1657	WI-SU-1673	WI-SU-1689	WI-SU-1705
13	16 FR ◦ 5.3MM	WI-SU-1642	WI-SU-1658	WI-SU-1674	WI-SU-1690	WI-SU-1706
14	17 FR ◦ 5.7MM	WI-SU-1643	WI-SU-1659	WI-SU-1675	WI-SU-1691	WI-SU-1707
15	18 FR ◦ 6.0MM	WI-SU-1644	WI-SU-1660	WI-SU-1676	WI-SU-1692	WI-SU-1708
16	19 FR ◦ 6.3MM	WI-SU-1645	WI-SU-1661	WI-SU-1677	WI-SU-1693	WI-SU-1709



TEAR DROP SUCTION TUBE (F/DESIGN) WITH MANDRIN WIRE

Sr. No.	Working Lenght Total Lenght Outer Diameter	S 100mm 165mm	M 115mm 180mm	L 140mm 205mm	LL 165mm 230mm	XL 195mm 260mm
1	3 FR ○ 1.0MM	WI-SU-1710	WI-SU-1719	WI-SU-1728	WI-SU-1737	WI-SU-1746
2	4 FR ○ 1.4MM	WI-SU-1711	WI-SU-1720	WI-SU-1729	WI-SU-1738	WI-SU-1747
3	5 FR ○ 1.7MM	WI-SU-1712	WI-SU-1721	WI-SU-1730	WI-SU-1739	WI-SU-1748
4	6 FR ○ 2.0MM	WI-SU-1713	WI-SU-1722	WI-SU-1731	WI-SU-1740	WI-SU-1749
5	7 FR ○ 2.3MM	WI-SU-1714	WI-SU-1723	WI-SU-1732	WI-SU-1741	WI-SU-1750
6	8 FR ○ 2.7MM	WI-SU-1715	WI-SU-1724	WI-SU-1733	WI-SU-1742	WI-SU-1751
7	9 FR ○ 3.0MM	WI-SU-1716	WI-SU-1725	WI-SU-1734	WI-SU-1743	WI-SU-1752
8	10 FR ○ 3.3MM	WI-SU-1717	WI-SU-1726	WI-SU-1735	WI-SU-1744	WI-SU-1753
9	12 FR ○ 4.0MM	WI-SU-1718	WI-SU-1727	WI-SU-1736	WI-SU-1745	WI-SU-1754

RICHTER SUCTION TUBE (LIPO SUCTION)



WI-SU-1755

RICHTER SUCTION TUBE ,DIA 3.0MM WITH 3 SUCTION HOLE 20CM WORKING LENGTH



WI-SU-1756

RICHTER SUCTION TUBE ,DIA 3.0MM WITH 3 SUCTION HOLE 20CM WORKING LENGTH



WI-SU-1757

RICHTER SUCTION TUBE ,DIA 3.0MM WITH 3 SUCTION HOLE 30CM WORKING LENGTH

RICHTER SUCTION TUBE (LIPO SUCTION)



WI-SU-1758
RICHTER SUCTION TUBE ,DIA 4.0MM WITH 3 SUCTION HOLE 20CM WORKING LENGTH



WI-SU-1759
RICHTER SUCTION TUBE ,DIA 4.0MM WITH 3 SUCTION HOLE 20CM WORKING LENGTH

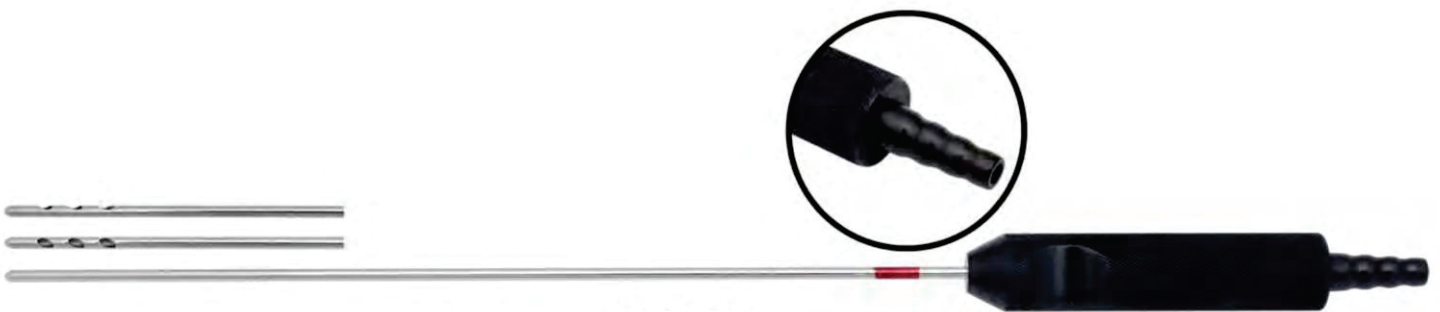

WI-SU-1760
RICHTER SUCTION TUBE ,DIA 4.0MM WITH 3 SUCTION HOLE 30CM WORKING LENGTH

RICHTER SUCTION TUBE (LIPO SUCTION)

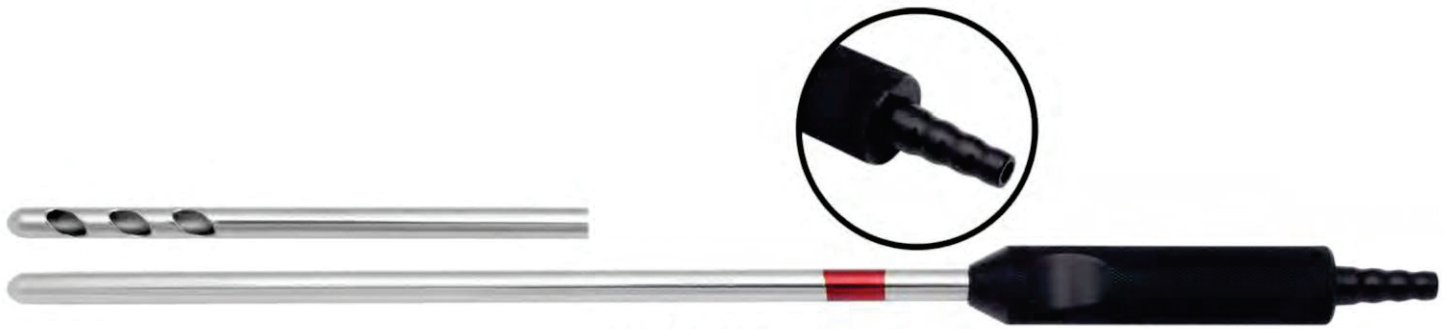

WI-SU-1761

RICHTER SUCTION TUBE ,DIA 10.0MM WITH 3 SUCTION HOLE 29.5CM WORKING LENGTH

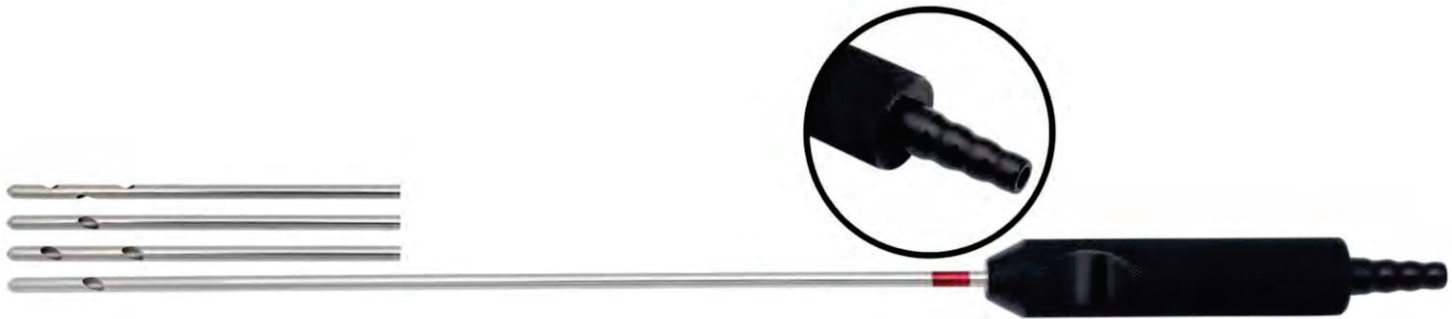

WI-SU-1762

RICHTER SUCTION TUBE ,DIA 5.0MM WITH 3 SUCTION HOLE 30CM WORKING LENGTH



WI-SU-1763

RICHTER SUCTION TUBE ,DIA 4.0MM WITH 3 SUCTION HOLE 20CM WORKING LENGTH

RICHTER SUCTION TUBE (LIPO SUCTION)

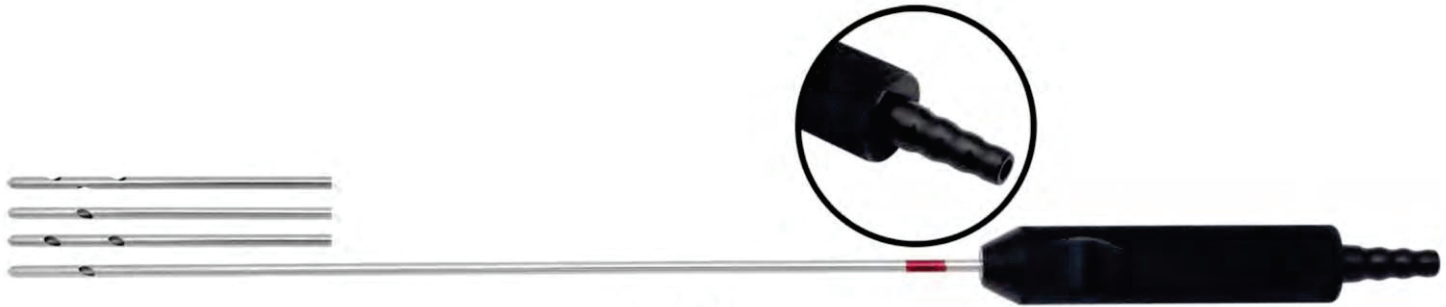

WI-SU-1764

RICHTER SUCTION TUBE ,DIA 4.0MM WITH 3 SUCTION HOLE 30CM WORKING LENGTH



WI-SU-1765

RICHTER SUCTION TUBE ,DIA 5.0MM WITH 3 SUCTION HOLE 20CM WORKING LENGTH



WI-SU-1766

RICHTER SUCTION TUBE ,DIA 5.0MM WITH 3 SUCTION HOLE 30CM WORKING LENGTH



WI-SU-1767 /FG DIA 4.7MM
WI-SU-1768 /FG DIA 3.0MM
VASECTOMY RING FORCEPS
14CM FULL GOLD



WI-SU-1769 /FG 12.5 CM CVD
VESECTOMY FINE MOSQUITO FORCEPS
FULL GOLD



WI-SU-1770 /FG 9 CM
WI-SU-1771 /FG 11.5 CM
BACKHAUS TOWEL CLAMP
FULL GOLD

VASECTOMY SET



WI-SU-1772 /FG 9 CM
2 PCS

WI-SU-1773 /FG 11.5 CM
1 PCS

WI-SU-1774 /FG DIA 3.0MM
1 PCS

WI-SU-1775 /FG DIA 4.7MM
1 PCS

WI-SU-1776 /FG 12.5 CM CVD
2 PCS



WITTEX
INTERNATIONAL

Manufacturers & Exporters of Single Use Instruments

HEGARS

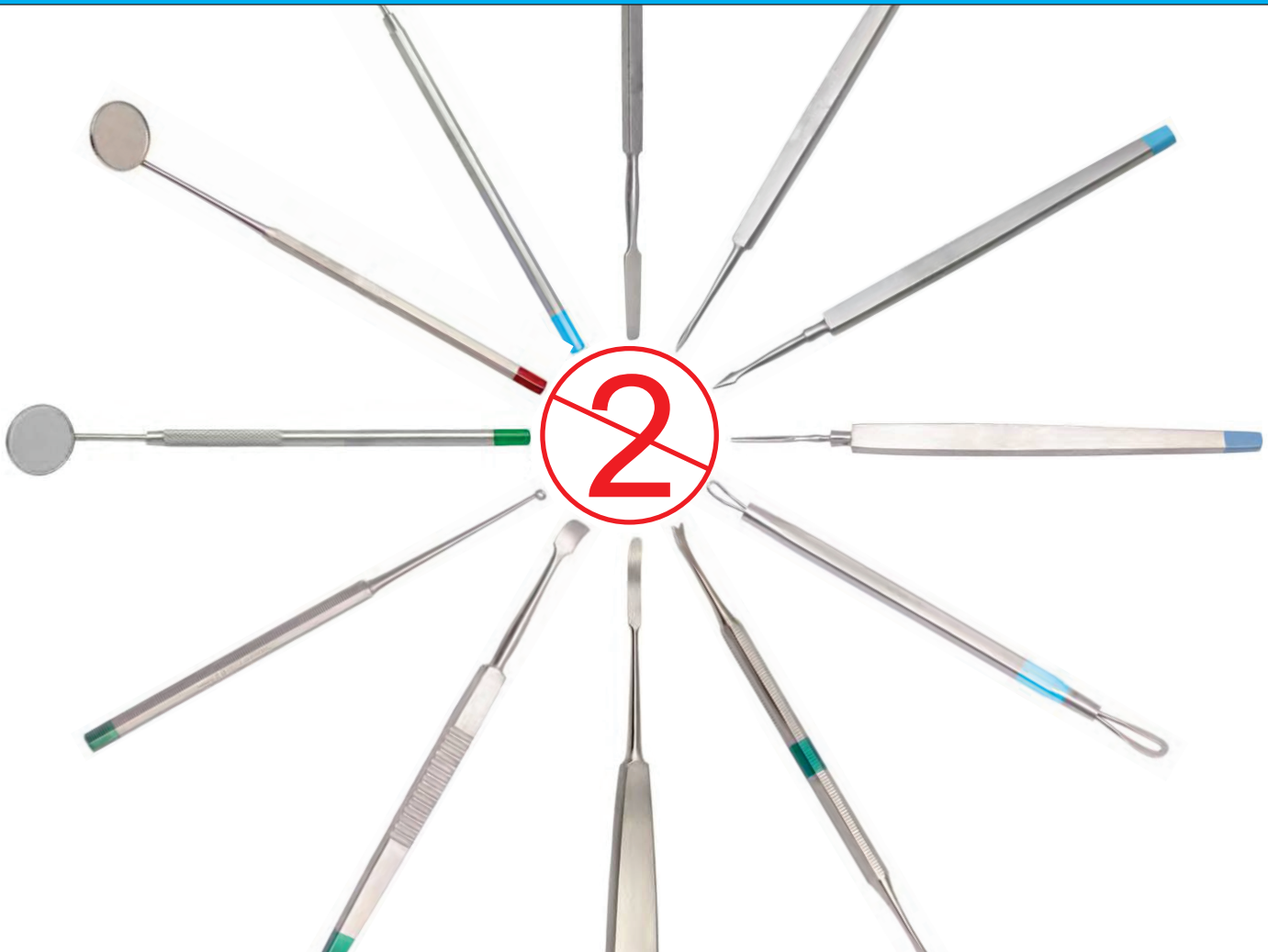

 www.wittex.com



WI-SU-1777
TEAR DROP SUCTION CANNULA TUBE RIGHT ANGLED TIP CURVED



WI-SU-1778
TEAR DROP SUCTION CANNULA TUBE LIFT ANGLED TIP CURVED



WI-SU-1779
SCLERAL DUAL MARKER 3,5 / 4,0 MM, 75.0MM



TAGO 1133 / WI-SU-1780
GOUGE SHARP 1.2X15MM 12CM



TAGO 1122 / WI-SU-1781
GOUGE AERO SHAPE POINT 12.5CM



TAGO 1100 / WI-SU-1782
GOUGE 1.4X6.8MM 12.5CM



TAFK 2911 / WI-SU-1783
MacDONALD DISSECTOR DOUBLE ENDED,
BLUNT/BLUNT 19CM



WI-SU-1784
WI-SU-1785
FIG 000
Ø 6MM



WI-SU-1786
WI-SU-1787
FIG 00
Ø 8MM



WI-SU-1788
WI-SU-1789
FIG 0
Ø 10MM

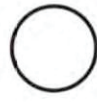

WI-SU-1790
WI-SU-1791
FIG 1
Ø 12MM

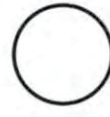

WI-SU-1792
WI-SU-1793
FIG 2
Ø 14MM

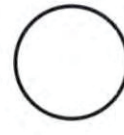

WI-SU-1794
WI-SU-1795
FIG 3
Ø 16MM

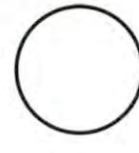

WI-SU-1796
WI-SU-1797
FIG 4
Ø 18MM

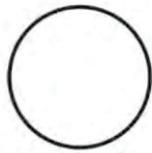

WI-SU-1798
WI-SU-1799
FIG 5
Ø 20MM

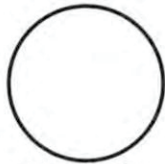

WI-SU-1800
WI-SU-1801
FIG 6
Ø 22MM

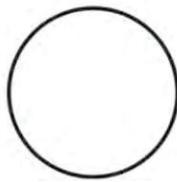

WI-SU-1802
WI-SU-1803
FIG 7
Ø 24MM

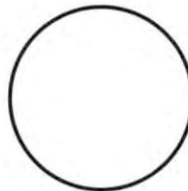

WI-SU-1804
WI-SU-1805
FIG 8
Ø 26MM

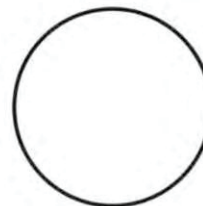

WI-SU-1806
WI-SU-1807
FIG 9
Ø 28MM

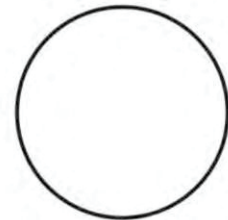

WI-SU-1808
WI-SU-1809
FIG 10
Ø 30MM



WI-SU-1810
LARYNGEAL MIRROR
with HEXAGONAL
HANDLE COMPLETE
18CM
(MIRROR SIZE OPTIONAL)



WI-SU-1811
MOUTH MIRROR
WITH ADJUSTABLE
ROUND HANDLE 12CM
(MIRROR SIZE OPTIONAL)



WI-SU-1812
MOUTH MIRROR HANDLE
WITH FIX MIRROR **19CM**
(MIRROR SIZE OPTIONAL)



WI-SU-1813
MOUTH MIRROR
WITH ADJUSTABLE
PRINT HANDLE 12CM
(MIRROR SIZE OPTIONAL)



WI-SU-1814
MOUTH MIRROR
WITH ADJUSTABLE
PLAIN HANDLE 12CM
(MIRROR SIZE OPTIONAL)



UTERINE DILATORS



WI-SU-1824	3 + 4 MM
WI-SU-1825	5 + 6 MM
WI-SU-1826	7 + 8 MM
WI-SU-1827	9 + 10 MM
WI-SU-1828	11 + 12 MM
WI-SU-1829	13 + 14 MM
WI-SU-1830	15 + 16 MM
WI-SU-1831	17 + 18 MM

WI-SU-1823 - TAEM 2399
HEGAR
UTERINE DILATOR



WI-SU-1832
HEGAR
UTERINE DILATOR SET

VAGINAL SPECULA
LOWER BLADER



WI-SU-1833
110 X 18MM
215MM



WI-SU-1834
110 X 20MM
215MM



WI-SU-1835
110 X 27MM
220MM



WI-SU-1836
110 X 30MM
220MM



WI-SU-1837
110 X 36MM
225MM



KRISTELLER
LOWER BLADES

VAGINAL SPECULA
LOWER BLADES



KRISTELLER
LOWER BLADES



WI-SU-1838 |
70 X 15 MM
175 MM



WI-SU-1839
70 X 27 MM
180 MM



WI-SU-1840 |
75 X 30 MM
180 MM



WI-SU-1841
90 X 36 MM
185 MM

VAGINAL SPECULA - UPPER BLADES

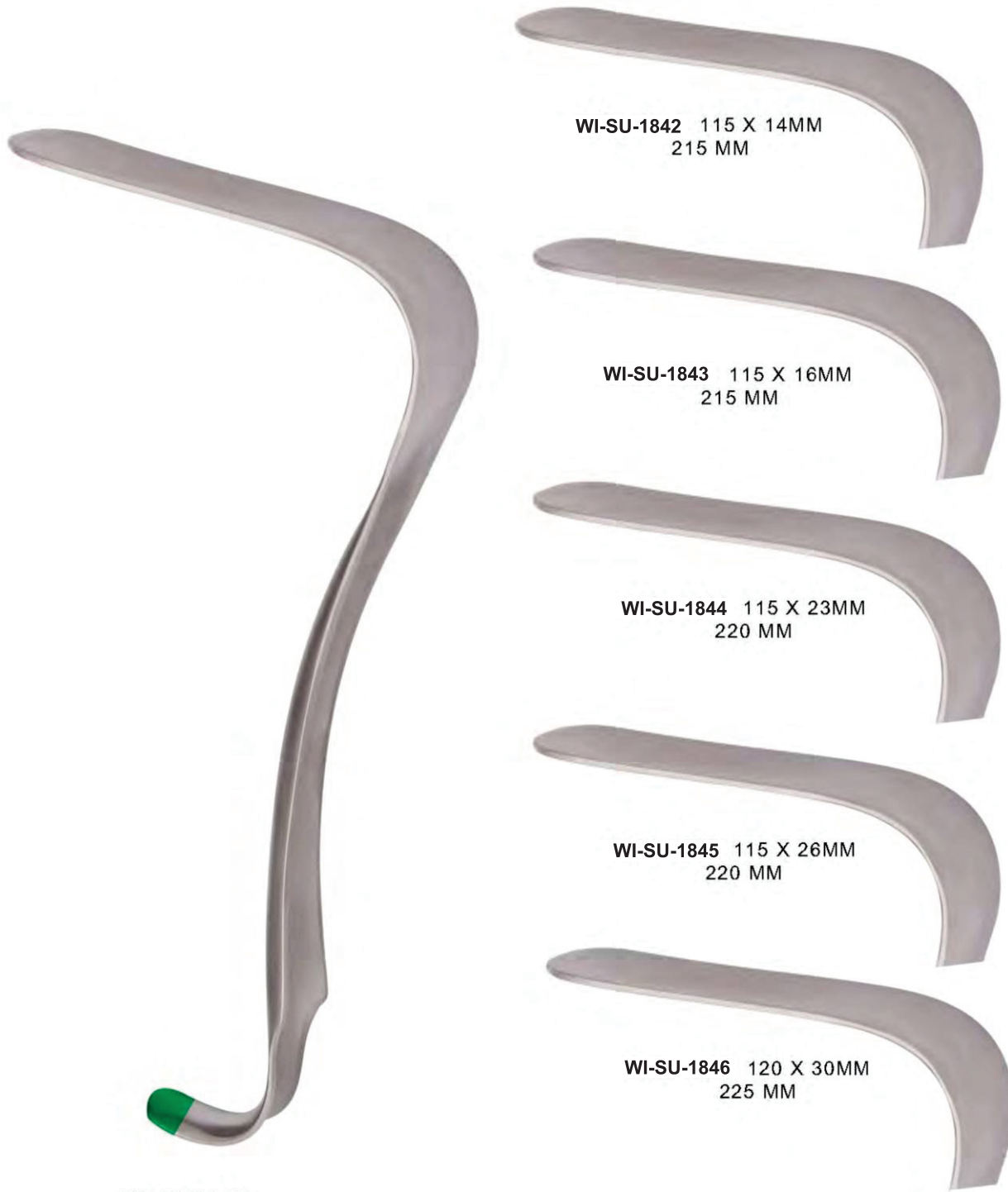

WI-SU-1842 115 X 14MM
215 MM

WI-SU-1843 115 X 16MM
215 MM

WI-SU-1844 115 X 23MM
220 MM

WI-SU-1845 115 X 26MM
220 MM

WI-SU-1846 120 X 30MM
225 MM

KRISTELLER
UPPER BLADES

VAGINAL SPECULA -SET, UPPER & LOWER BLADES



KRISTELLER
170 MM
WI-SU-1847 70 X 15MM



KRISTELLER
175 MM
WI-SU-1848 70 X 27 MM
WI-SU-1849 75 X 30 MM
WI-SU-1850 90 X 36 MM



SEIDEL 170 MM
WI-SU-1851 80 X 8 MM
WI-SU-1852 80 X 10 MM
WI-SU-1853 90 X 14 MM

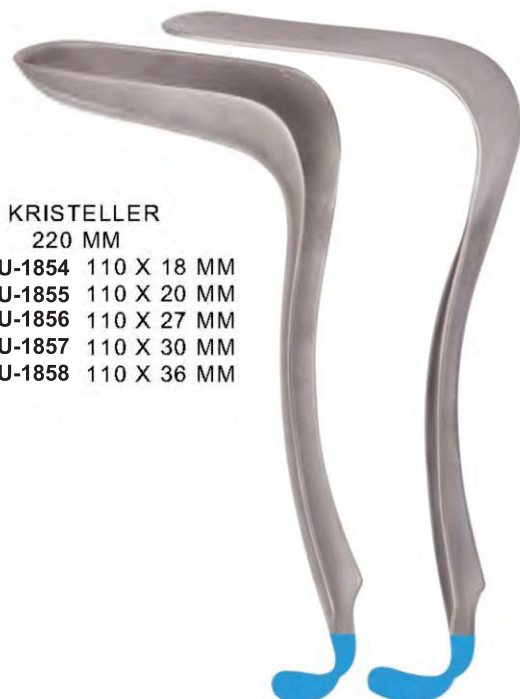

KRISTELLER
220 MM
WI-SU-1854 110 X 18 MM
WI-SU-1855 110 X 20 MM
WI-SU-1856 110 X 27 MM
WI-SU-1857 110 X 30 MM
WI-SU-1858 110 X 36 MM

VAGINAL SPECULA - UPPER BLADES

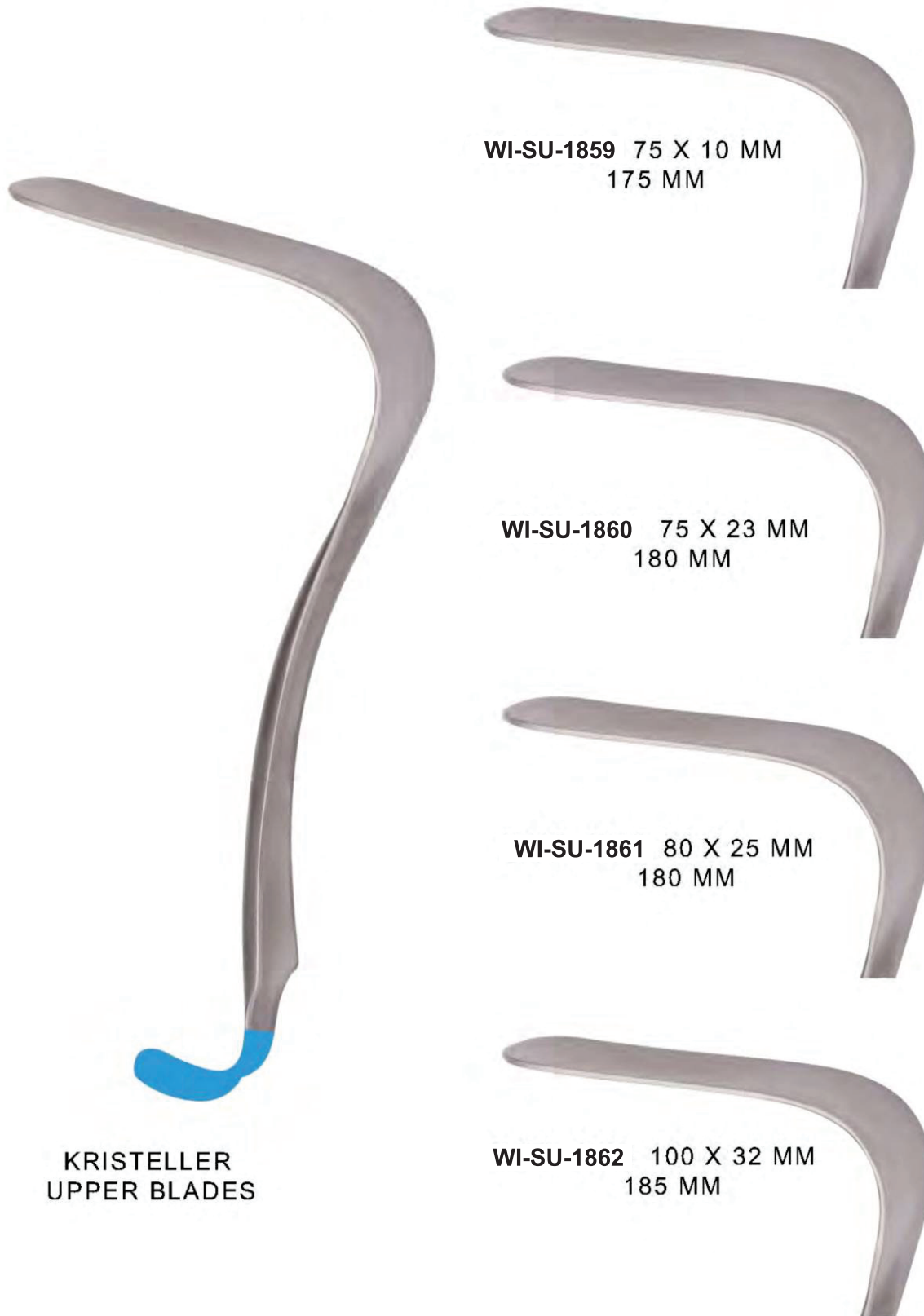

KRISTELLER
UPPER BLADES



WI-SU-1863 4.0MM
WI-SU-1864 1.7MM

CURETTE & CHALAZION
(B) ROUND EYE BALL
11.5CM



WI-SU-1865 1MM
WI-SU-1866 2MM
WI-SU-1867 3MM
WI-SU-1868 4MM

CHALAZION & CURETTE
(B) ROUND EYE BALL
PLAIN HANDLE 13.5CM



TABH 0786
BLACKHEAD REMOVER
13CM



TAHH 3055
DERMATOLOGY CURETTE
11CM



WI-SU-1869
LUNIATSCHEK SHARP
COTTON PLUGGER
18CM



WI-SU-1870
LUNIATSCHEK MEDIUM
COTTON PLUGGER
18CM



WI-SU-1871
JOEPP RASPATORY
4MM WIDE 18CM



WI-SU-1872
JOEPP RASPATORY
6MM WIDE 18CM



WI-SU-1873
VIDAL SCRAPER
SHARP, 13.5CM



WI-SU-1874
O/D 1.5mm



WI-SU-1875
O/D 2.0mm



WI-SU-1876
O/D 2.5mm



WI-SU-1877
O/D 3.0mm



WI-SU-1878
O/D 4.0mm



BUCK EAR CURETTES
CURVED BLUNT 15CM



GRAVE VAGINAL SPECULA

WI-SU-1879 75 X 20MM
WI-SU-1880 95 X 30MM
WI-SU-1881 115 X 36MM



CUSCO VAGINAL SPECULUM

WI-SU-1882 75 X 17MM
WI-SU-1883 80 X 24MM
WI-SU-1884 80 X 32MM
WI-SU-1885 90 X 36MM
WI-SU-1886 110 X 37MM
WI-SU-1887 100 X 25MM
WI-SU-1888 115 X 35MM
WI-SU-1889 120 X 17MM

WI-SU-1890 105 X 27MM
 SWISS PATTERN



COLLIN VAGINAL SPECULA

WI-SU-1891 100/90MM 28MM
WI-SU-1892 100/90MM 32MM
WI-SU-1893 105/95MM 35MM
WI-SU-1894 115/105MM 40MM



WITTEX
INTERNATIONAL

Manufacturers & Exporters of Single Use Instruments

SCALPEL HANDLES



 www.wittex.com

Scalpel Handles



For Blades fig.10 - 15 and fig. 40, 42



WI-SU-1895
BARRON
SCALPEL HANDLE
13CM



WI-SU-1896
SCALPEL HANDLE
No 4 13.5CM



WI-SU-1897
BP HANDLE # 3
SCALPEL HANDLE
12.5CM



WI-SU-1898
BP HANDLE
WITH SCALE
No 3 12.5CM



WI-SU-1899
BP HANDLE
NO 3L LONG
21CM



For blades fig. 10 - 15 and fig. 40, 42

Scalpel Handles



WI-SU-1903
SCALPEL HANDLE
No 3 XL 25CM



BARRE
WI-SU-1904
FOR LEFT HAND
25CM



WI-SU-1900



WI-SU-1901
12°



WI-SU-1902
25°



corresponds
with english
No. 5

WI-SU-1905
SCALPEL HANDLE
No 7 16CM



WI-SU-1906
FOR MICRO-BLADE
15.5CM

Scalpel Handles



For blades fig. 18 - 36



WI-SU-1907
SCALPEL HANDLE
No 4L 21.5CM



WI-SU-1908
SCALPEL HANDLE
No 4XL 25CM



WI-SU-1909
SCALPEL HANDLE
No 4XL 22.5CM



WI-SU-1910
SCALPEL HANDLE
No 8 13CM



WI-SU-1911
SCALPEL HANDLE
No 8 14.5CM



WI-SU-1912
CHERON DRESSING FORCEPS
serrated box lock handles
angled to side with ratchet
straight 24CM



WI-SU-1913 **WI-SU-1915** 14CM
WI-SU-1914 **WI-SU-1916** 16CM

DANDY Hemostatic Forceps
curved to side delicate blunt



VERY DELICATE,
WITH 0.2mm PITCH OF SERRATION
WI-SU-1917 13.5CM STR
WI-SU-1918 15.5CM STR
WI-SU-1919 17.5CM STR
WI-SU-1920 21.5CM STR
WI-SU-1921 23.5CM STR

WI-SU-1922 13.5CM STR
WI-SU-1923 17.5CM STR
WI-SU-1924 19.5CM STR
WI-SU-1925 26.5CM STR

RYDER NEEDLE HOLDER

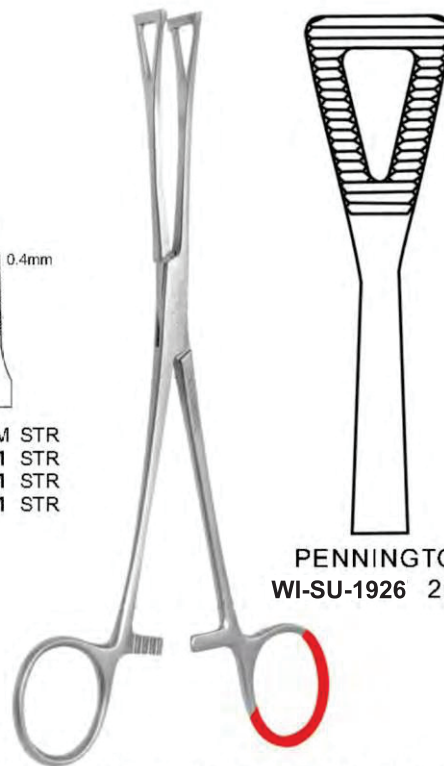

PENNINGTON
WI-SU-1926 20CM

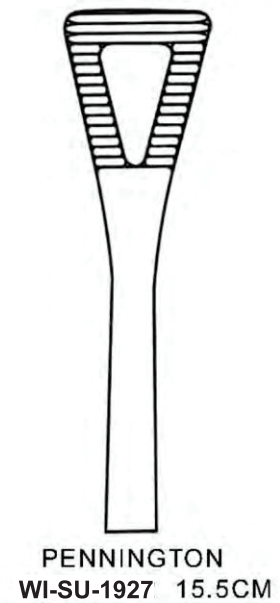

PENNINGTON
WI-SU-1927 15.5CM

INTESTINAL GRASPING FORCEPS



WI-SU-1928 20CM
LOCKWOOD



WI-SU-1929 14CM
COLLIN



WI-SU-1930 23CM
DUVAL

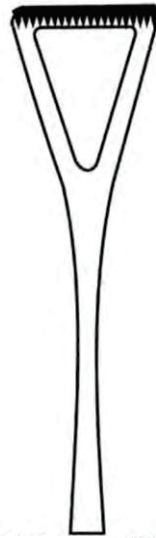

WI-SU-1931 18CM
COLLIN



INTESTINAL GRASPING FORCEPS
straight toothed

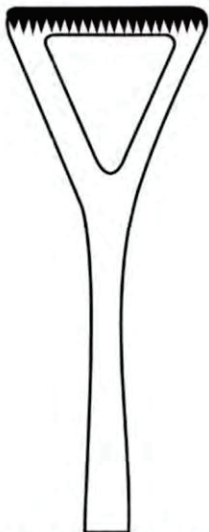

WI-SU-1932 19.5CM
DUVAL-COLLIN

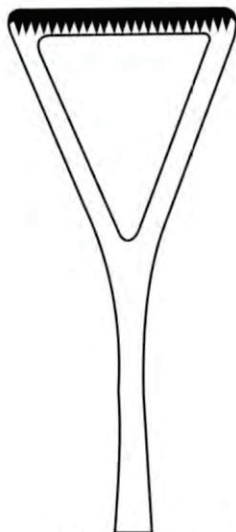

WI-SU-1933 20CM
DUVAL-COLLIN

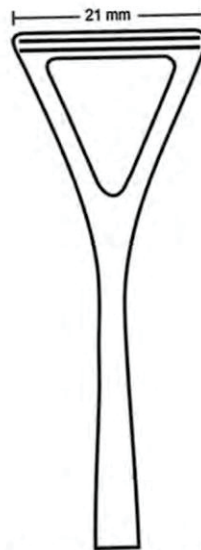

WI-SU-1934 19.5CM
COLLIN

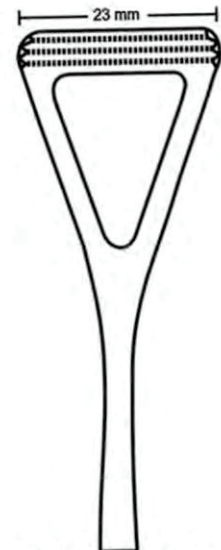

WI-SU-1935 23CM
COLLIN

HARTMANN
WI-SU-1936 29mm
NASAL SPECULA , LIGHT PATTERN
14CM



TIECK-HALLE
WI-SU-1937 16mm
WI-SU-1938 19mm
NASAL SPECULA ,ASEPTIC JOINT
USE FOR INFANTS , 14CM



WI-SU-1939 **WI-SU-1940**

HARTMANN-HALLE
WI-SU-1941 23mm
WI-SU-1942 27mm
WI-SU-1943 31mm
NASAL SPECULA ASEPTIC JOINT
15CM



WI-SU-1944 **WI-SU-1945** **WI-SU-1946**

HARTMANN
WI-SU-1947 28mm
WI-SU-1948 30mm
WI-SU-1949 32mm
 NASAL SPECULA, SCREW JOINT
 15CM

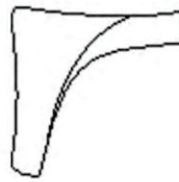

WI-SU-1950



WI-SU-1951



WI-SU-1952

HARTMANN
WI-SU-1953 27mm
 NASAL SPECULA,, ASEPTIC JOINT
 14CM



WI-SU-1954

HARTMANN-HALLE
WI-SU-1955 23mm
WI-SU-1956 28mm
WI-SU-1957 32mm
 NASAL SPECULA SCREW JOINT
 15CM



WI-SU-1958



WI-SU-1959



WI-SU-1960

BECKMANN
WI-SU-1961 17mm
NASAL SPECULA, SCREW JOINT,
FOR USE IN INFANTS, CVD,
SIDEWARDS, 14CM



WI-SU-1962

BECKMANN
WI-SU-1963 26mm
EAR & NASAL SPECULUM,
CVD, SIDEWARDS
15CM



WI-SU-1964

KILLIAN
WI-SU-1965 FIG 1 36 X 7mm
WI-SU-1966 FIG 2 56 X 7mm
WI-SU-1967 FIG 3 75 X 7mm
WI-SU-1968 FIG 4 90 X 7mm
SEPTUM SPECULA ,ASEPTIC JOINT
14CM

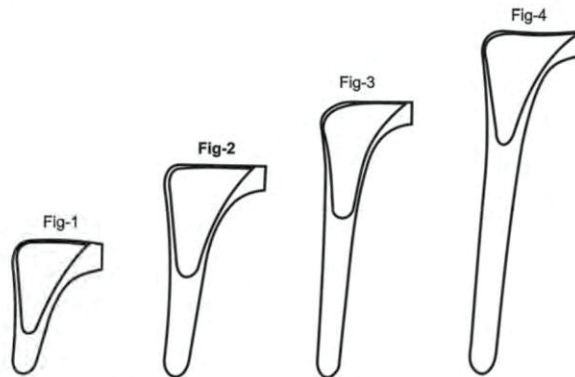

WI-SU-1969 **WI-SU-1970** **WI-SU-1971** **WI-SU-1972**

WIENER MODELL
WI-SU-1973 35mm
NASAL SPECULA, SCREW JOINT,
LARGE, HEAVY PATTERN
14CM



WI-SU-1974

WIENER MODELL
WI-SU-1975 29mm
NASAL SPECULA, SCREW JOINT,
MEDIUM PATTERN
14CM



WI-SU-1976

WIENER MODELL
WI-SU-1977 29mm
NASAL SPECULA, SCREW JOINT,
LIGHT PATTERN
14CM



WI-SU-1978



WI-SU-1979 STR 14cm
WI-SU-1980 CVD 14cm

**METZENBAUM (BABY)DISSECTING
SCISSORS**



WI-SU-1981 STR
WI-SU-1982 CVD

**METZENBAUM
DISSECTING SCISSORS
LARGE RING 14.5CM**



**WI-SU-1983 (OLD) WI-SU-1984 (NEW)
Nail Scissors CVD,
11 cm**

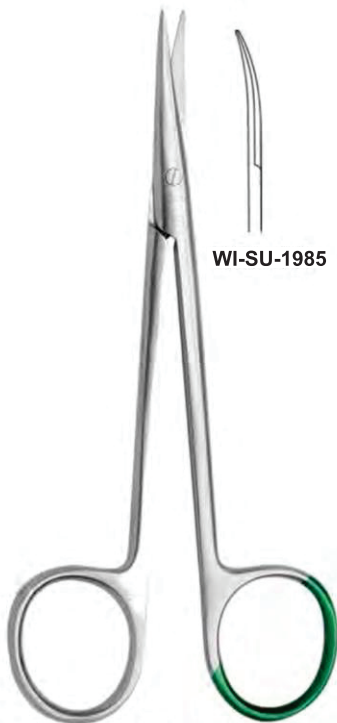

WI-SU-1985

**JAMESON / REYNOLDS
SCISSORS CVD 13cm**



WI-SU-1986 20cm
**EPISIOTOMY SCISSORS
HEAVY PATTERN
ONE BLADE SERRATED**

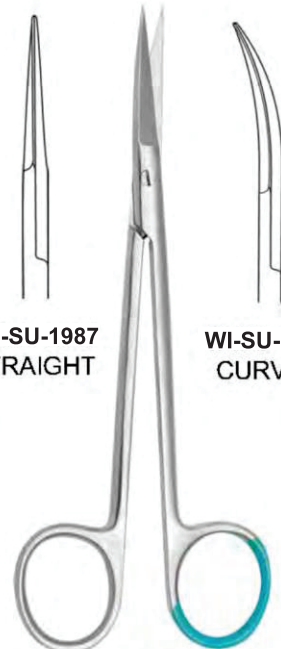

WI-SU-1987
STRAIGHT

WI-SU-1988
CURVED

JOSEPH DISSECTING SCISSORS SH/SH



UNVIERSAL BANDAGE SCISSORS FULL BLACK 16CM

- WI-SU-1989FB BLACK HANDLE
- WI-SU-1990FB RED HANDLE
- WI-SU-1991FB BLUE HANDLE
- WI-SU-1992FB YELLOW HANDLE
- WI-SU-1993FB ORANGE HANDLE
- WI-SU-1994FB PINK HANDLE
- WI-SU-1995FB LIGHT GREEN HANDLE
- WI-SU-1996FB VIOLET HANDLE



UNVIERSAL BANDAGE SCISSORS FULL BLACK 18CM

- WI-SU-1997FB BLACK HANDLE
- WI-SU-1998FB RED HANDLE
- WI-SU-1999FB BLUE HANDLE
- WI-SU-2000FB YELLOW HANDLE
- WI-SU-2001FB ORANGE HANDLE
- WI-SU-2002FB PINK HANDLE
- WI-SU-2003FB LIGHT GREEN HANDLE
- WI-SU-2004FB VIOLET HANDLE



UNVIERSAL BANDAGE SCISSORS 18CM

- WI-SU-2005 BLACK HANDLE
- WI-SU-2006 RED HANDLE
- WI-SU-2007 BLUE HANDLE
- WI-SU-2008 YELLOW HANDLE
- WI-SU-2009 ORANGE HANDLE
- WI-SU-2010 PINK HANDLE
- WI-SU-2011 LIGHT GREEN HANDLE
- WI-SU-2012 VIOLET HANDLE



UNVIERSAL BANDAGE SCISSORS 16CM

- WI-SU-2013 BLACK HANDLE
- WI-SU-2014 RED HANDLE
- WI-SU-2015 BLUE HANDLE
- WI-SU-2016 YELLOW HANDLE
- WI-SU-2017 ORANGE HANDLE
- WI-SU-2018 PINK HANDLE
- WI-SU-2019 LIGHT GREEN HANDLE
- WI-SU-2020 VIOLET HANDLE



WI-SU-2021 13 CM
TOW NOTCHES
PLACTIC HANDLE SCISSORS



WI-SU-2022 SH/SH
PLASTIC HANDLE SCISSORS
11 CM



WI-SU-2023 10CM
WI-SU-2024 12CM
UMBILICAL CODE
AMERICAN PATTERN SCISSORS



WI-SU-2025 SH/SH
TAILOR TYPE PLASTIC HANDLE
13 CM



WI-SU-2026
SKIN STAPLE REMOVER
PLASTIC HANDLE 10CM



WI-SU-2027
SKIN STAPLE REMOVER
10CM



WI-SU-2028
HARTMANN EAR FORCEPS STR 8CM SHAFT LENGTH
4MM TIP.

WI-SU-2029
HARTMANN EAR FORCEPS STR 8CM SHAFT LENGTH
5MM TIP.

WI-SU-2030
HARTMANN EAR FORCEPS STR 8CM SHAFT LENGTH
6MM TIP.

WI-SU-2031
HARTMANN EAR FORCEPS STR 8CM SHAFT LENGTH
7MM TIP.



WI-SU-2032
TILLEY NASAL DRESSING FORCEPS
13CM

WI-SU-2033
TILLEY NASAL DRESSING FORCEPS
14CM

WI-SU-2034 / 4111
TILLEY NASAL DRESSING FORCEPS
16CM

WI-SU-2035
TILLEY NASAL DRESSING FORCEPS
20CM



WI-SU-2036
HARTMANN NASAL DRESSING FORCEPS
17.5CM



WI-SU-2037



WI-SU-2038



WI-SU-2039

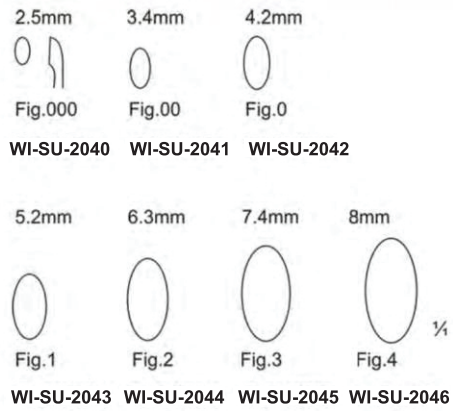

SCHEIDE BONE CURETTE
TAFK 6211 - TAFK 6277
17cm

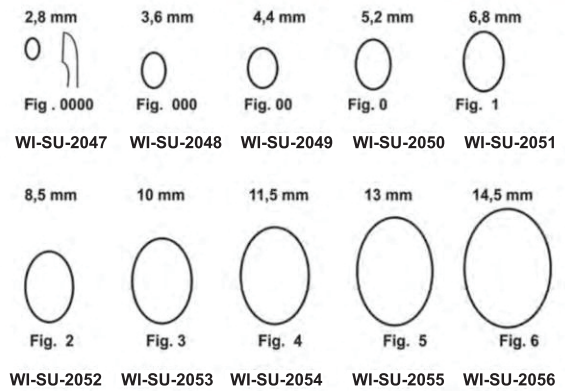

VOLKMANN BONE CURETTE
TAFK 6300 - TAFK 6399
17cm

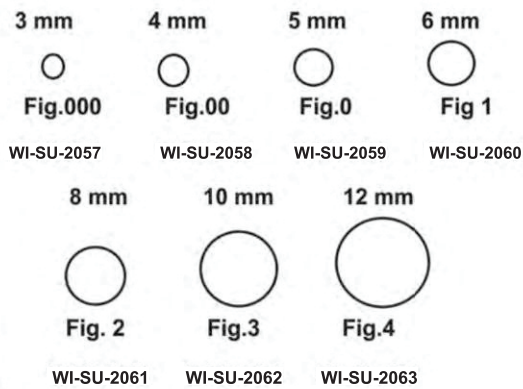

BRUNS BONE CURETTE
TAFK 6111-TAFK 6177
17cm



CANNULA SUCTION NEEDLE STR
140MM

WI-SU-2064	1.0mm
WI-SU-2065	1.2mm
WI-SU-2066	1.5mm
WI-SU-2067	1.9mm
WI-SU-2068	2.0mm
WI-SU-2069	2.2mm

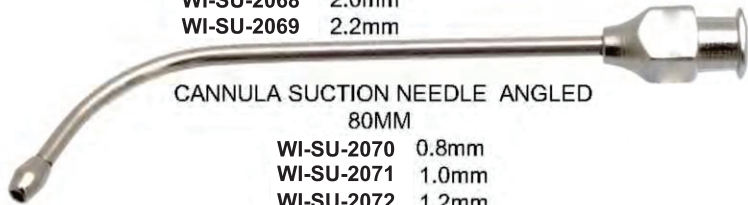

CANNULA SUCTION NEEDLE ANGLED
80MM

WI-SU-2070	0.8mm
WI-SU-2071	1.0mm
WI-SU-2072	1.2mm
WI-SU-2073	1.5mm
WI-SU-2074	1.9mm
WI-SU-2075	2.0mm
WI-SU-2076	2..2mm

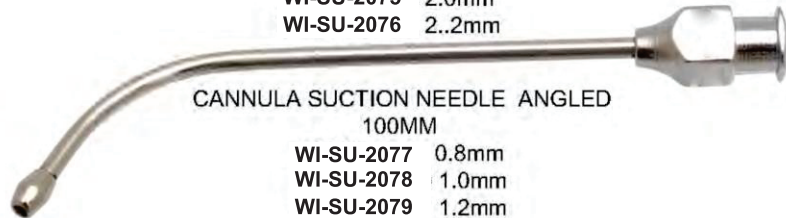

CANNULA SUCTION NEEDLE ANGLED
100MM

WI-SU-2077	0.8mm
WI-SU-2078	1.0mm
WI-SU-2079	1.2mm
WI-SU-2080	1.5mm
WI-SU-2081	1.9mm
WI-SU-2082	2.0mm
WI-SU-2083	2..2mm

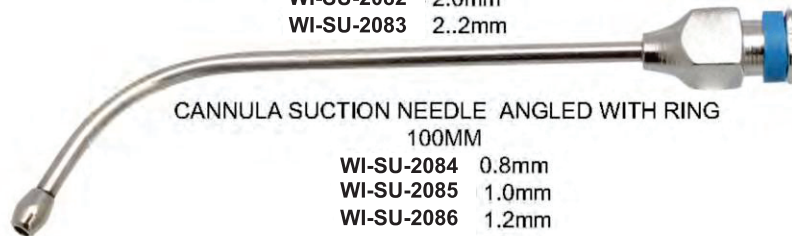

CANNULA SUCTION NEEDLE ANGLED WITH RING
100MM

WI-SU-2084	0.8mm
WI-SU-2085	1.0mm
WI-SU-2086	1.2mm
WI-SU-2087	1.5mm
WI-SU-2088	1.9mm
WI-SU-2089	2.0mm
WI-SU-2090	2..2mm

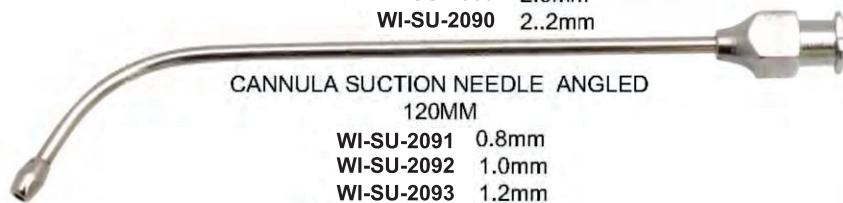

CANNULA SUCTION NEEDLE ANGLED
120MM

WI-SU-2091	0.8mm
WI-SU-2092	1.0mm
WI-SU-2093	1.2mm
WI-SU-2094	1.5mm
WI-SU-2095	1.9mm
WI-SU-2096	2.0mm
WI-SU-2097	2..2mm

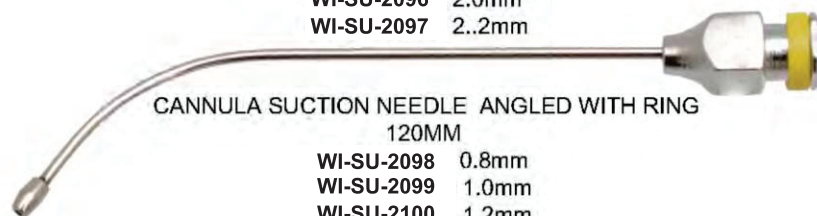

CANNULA SUCTION NEEDLE ANGLED WITH RING
120MM

WI-SU-2098	0.8mm
WI-SU-2099	1.0mm
WI-SU-2100	1.2mm
WI-SU-2101	1.5mm
WI-SU-2102	1.9mm
WI-SU-2103	2.0mm
WI-SU-2104	2..2mm



WITTEX
INTERNATIONAL

— MANUFACTURERS & EXPORTERS OF SINGLE USE INSTRUMENTS —

THANK YOU

FOR VIEWING OUR CATALOGUE

Wazirabad Road, Harar Sialkot 51310 - Pakistan.



+92 52 3574265 Fax: +92 52 3574266



wittex.export@gmail.com



wittex.international@gmail.com



www.wittex.com



+92 302 6145700 / +92 300 6810073
+92 302 6145700



PRECISION . QUALITY . TRUST .

